





Il **Gruppo Gnutti Cirillo** costituisce una delle principali realtà dell'imprenditorialità bresciana sin dagli anni '50, con un'attività ben radicata nel territorio. Un Gruppo di aziende che detiene l'intera filiera tecnico-produttiva e trasforma la materia prima in prodotto finito. Un accordo perfetto tra Tradizione, Professionalità, Qualità, Tecnologia e Know-How per poter offrire ogni giorno il miglior servizio. Il Gruppo Gnutti nasce dallo sviluppo e dalla crescita di Gnutti Cirillo S.p.A.

*The **Gnutti Cirillo Group** has been one of the cornerstones of industry in the Brescia area since the 1950s with activities that are deeply-rooted in the region: a Group of companies covering the whole technical-productive supply chain, able to transform raw material into finished products. A perfect mix of Tradition, Professionalism, Quality, Technology and Know-how in order to offer the very best service every day. The Gnutti Group springs from the development and growth of Gnutti Cirillo S.p.A.*





Tiemme Raccorderie nasce negli anni '80 come azienda che produce e distribuisce raccordi, valvole in ottone e tubazioni. Nel 1994 entra a far parte del Gruppo Gnutti, anno in cui l'azienda conosce una svolta radicale. Gli anni 2000 rappresentano una fase di ulteriore crescita ed evoluzione dell'azienda attraverso lo sviluppo di sistemi integrati nell'ambito del riscaldamento. Nel 2012 nasce presso la sede di Castegnato "Tiemme Lab", l'innovativo laboratorio termotecnico di Tiemme. Le filiali in Spagna, Grecia e Romania vogliono rispondere ad un mercato sempre più vasto ed esigente dirigendo lo sguardo aziendale verso un'ottica di internazionalizzazione.

Tiemme Raccorderie was established in the 1980s as a production and marketing company for brass fittings, valves and pipes. It joined the Gnutti Group in 1994, when the company underwent a radical change. The new millennium saw a further phase of growth and evolution for the company through the development of integrated systems in the hvac sector. In 2012 the innovative thermal engineering laboratory "Tiemme Lab" was established in the headquarter of Castegnato (Bs). Horizons were internationalized with the foundation of subsidiaries in Spain, Greece and Romania to meet the needs of a wider and more demanding market.



Gnutti Cirillo S.p.A. è l'azienda capogruppo, fondata nel 1951 da Cirillo Gnutti come azienda meccanica per la costruzione di attrezzature e stampi, oggi è leader mondiale nello stampaggio a caldo e nella lavorazione meccanica dell'ottone e di altri metalli non ferrosi. Gnutti Cirillo S.p.A. ha raggiunto un' elevata competenza tecnica che le permette di soddisfare qualsiasi richiesta grazie all'autosufficienza nella filiera produttiva.

Partendo dalla progettazione, passando per la costruzione delle attrezzature e utensilerie, lo stampaggio a caldo dell'ottone, le lavorazioni, i trattamenti superficiali, gli assemblaggi automatici fino al confezionamento del prodotto finito; il tutto realizzato internamente al gruppo con la possibilità di personalizzazione secondo le specifiche del cliente.

Alla sede storica di Lumezzane (BS) nel 2000 si è aggiunto lo stabilimento di Odolo (BS).

Gnutti Cirillo S.p.A. is the parent company, founded in 1951 by Cirillo Gnutti as a mechanical engineering firm building tools and dies, it is now the world leader in hot forging and machining of brass and other non-ferrous metals. Gnutti Cirillo S.p.A. has compiled impressive technical expertise, enabling it to meet all requirements. The company is self-sufficient throughout its entire production chain, from design to completely in-house construction of tooling and equipment, from hot forging of brass to machining, surface treatments and automatic assembly up to the packaging of the finished product. Everything is customised to the customer's specifications. Alongside its historical location in Lumezzane (Brescia) in 2000 Gnutti Cirillo S.p.A. opened its new plant in Odolo (Brescia).



Negli anni il processo di internazionalizzazione del gruppo è proseguito con la costituzione di **Metal Forming Technology Inc.** Situata nello stato del Michigan (USA) MFT ha raggiunto elevati standard di efficienza nella produzione di articoli in ottone stampati a caldo e lavorati secondo le specifiche del cliente. L'azienda funge, inoltre, come centro logistico e di customer care per conto di Gnutti Cirillo S.p.A. per il mercato nord americano e canadese.

The process of internationalisation of the Group has proceeded over the years thanks to the establishment of Metal Forming Technology Inc. Located in the state of Michigan (USA) MFT has achieved high levels of efficiency in the production of hot forged and machined brass articles according to the customer's specifications. At the same time the company offers logistic and customer care services on behalf of Gnutti Cirillo S.p.A. to the North American and Canadian markets.



EMC Component è una società nata nel 2011, specializzata nella progettazione, produzione e commercializzazione di accessori per trasformatori elettrici di distribuzione e potenza.

EMC Component is a company founded in 2011, specialized in designing, manufacturing and trading accessories for power and distribution transformers.



EN ISO 9001:2008

La società ha sede a Castegnato in provincia di Brescia ed opera in due stabilimenti adiacenti, l'uno di circa 7.000 mq coperti, dove sono situati il reparto di produzione con macchine transfer e gli uffici, l'altro con una superficie di 15.000 mq dove sono situati i magazzini e il reparto PEX per la produzione del tubo in polietilene reticolato.

Il Sistema Qualità Tiemme Raccorderie® S.p.A. è lo strumento per garantire ai nostri Clienti prodotti e servizi che soddisfino le loro aspettative per qualità costante al massimo livello e per puntualità nella consegna, in un processo di miglioramento continuo, nel pieno rispetto della sicurezza e dell'ambiente.

Tiemme Raccorderie® S.p.A. ha ottenuto nel 1999 la certificazione ISO 9002 del proprio sistema di qualità e nel 2003 ha ottenuto la certificazione ISO 9001, conseguenza naturale della politica di qualità totale e di raggiungimento dell'eccellenza da sempre perseguita dall'azienda. I prodotti Tiemme Raccorderie® S.p.A. di eccellente manifattura e qualità sono controllati e riconosciuti in tutto il mondo da oltre 70 enti di omologazione tra i più prestigiosi. Una efficiente e moderna assistenza formata da tecnici addestrati è completamente a disposizione della clientela.

Partner

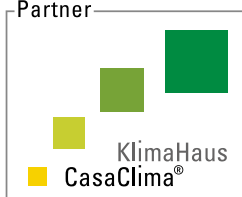



ROMANIA

BRANCH
Bucarest - Romania

UKRAINE

Representative offices
Kiev - Ukraine

SPAIN

BRANCH
Valencia - Spain

ALGERIA

BRANCH
Sidi Bel Abbes - Algeria

ITALY

TIEMME RACCORDERIE SPA

GREECE

BRANCH
Atene - Greece

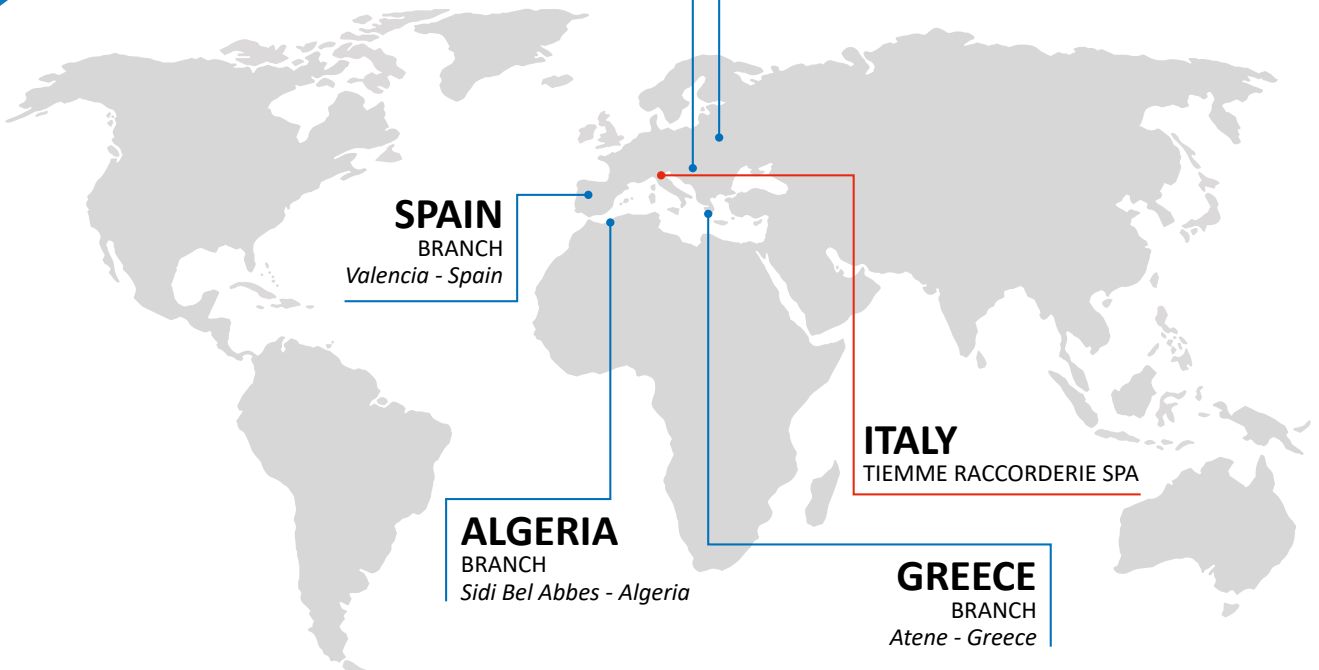



The company headquarters are located in Castegnato, in the province of Brescia and it works in two adjacent factories. The first facility covers 7,000 square metres and is home to the production department (with transfer machines) and to the offices, while the second covers 15,000 square metres containing the warehouses and the PE-X Division for the production of cross-linked polyethylene pipe.

The Tiemme Raccorderie® S.p.A. Quality System is the instrument which guarantees our Customers products and services that satisfy their expectations in terms of constant, maximum level quality and punctuality in delivery, in a process of continuous improvement, fully respecting safety and the environment.

In 1999, Tiemme Raccorderie® S.p.A. obtained ISO 9002 certification for its quality system, and in 2003 ISO 9001 as the natural consequence of the total quality policy and the obtainment of excellence the company has always strived for.

Tiemme Raccorderie® S.p.A. products of excellent manufacture and quality are controlled and known throughout the world by more than 70 of the most prestigious type-approval authorities. Our customers can freely avail themselves of an efficient and modern assistance service staffed by trained technicians.





CAP.
01

Valvole a sfera a passaggio standard e filettatura ISO 228 "MISTRAL"
"MISTRAL" standard bore ISO 228 thread ball valves

NEW
TIEMME © COPYRIGHT



What's new?

Nuove valvole MISTRAL Femmina/Femmina con leva piatta in acciaio INOX plastificata blu.
New MISTRAL ball valve female/female with flat INOX steel handle blue laminated.

PAG. **04**

2380XB

CAP.
01

Valvole a sfera a passaggio totale con premistoppa e filettatura ISO 228 "BURAN"
"BURAN" full bore iso 228 thread ball valves with adjustable packing gland

NEW
TIEMME © COPYRIGHT



What's new?

Nuova famiglia di valvole a sfera a passaggio totale con premistoppa e filettatura ISO 228.
 Disponibile in varie figure e attacchi.
*New range of full bore ball valves with adjustable packing gland and ISO 228 thread.
 Available in various figures and connections.*

PAG. **09**

2450N - 2451N - 2460N - 2461N - 2471N - 2472N

CAP.
01

Valvole a sfera a passaggio totale e filettatura ISO 7 "URAGANO"
"URAGANO" full bore ISO 7 thread ball valves

NEW
TIEMME © COPYRIGHT



What's new?

Nuova valvola della serie URAGANO con quadro di manovra da 28 mm.
New valve from the URAGANO series with 28mm. square head.

PAG. **16**

2271

CAP.
01

Valvole a sfera a passaggio totale e filettatura ISO 7 "URAGANO"
"URAGANO" full bore ISO 7 thread ball valves

NEW
TIEMME © COPYRIGHT



What's new?

Nuove valvole URAGANO per coibentazione Femmina/Femmina con leva piatta rossa.
New URAGANO valves for isolation female/female with flat red handle.

PAG. **18**

2232 - 2233

CAP.
01

Valvole a sfera motorizzate
Motorized ball valves

NEW
TIEMME © COPYRIGHT



What's new?

Realizzazione di una nuova famiglia di valvole a sfera motorizzate a passaggio totale
 Femmina/Femmina a 2 vie, per attuatori con basetta ISO 5211.
*Addition of a new family range of full bore motorized ball valves Female/Female 2 ways for
 actuators with ISO 5211.*

PAG. **36**
 PAG. **326**

2139

CAP.
01

Rubinetti e valvole a sfera per applicazioni speciali
Special applications bibcocks and ball valves

NEW
TIEMME © COPYRIGHT



What's new?

Rubinetto lavatrice cromato con comando a vitone.
Chromed bibcock for washing machine with rosette.

PAG. **39**

3908C

CAP.
01

Rubinetti e valvole a sfera per applicazioni speciali
Special applications bibcocks and ball valves

NEW



What's new?

Rubinetto cromato a squadra doppio completo di rosone.
Chrome-plated cut-off double, with rosette.

PAG. **40**

3909C

CAP.
01

Rubinetti e valvole a sfera per applicazioni speciali
Special applications bibcocks and ball valves

NEW



What's new?

Set cappuccio e rosone per valvole ad incasso.
Set cap and rounding for built-in valves.

PAG. **42**

PAG. **131**

PAG. **215**

2971SET

CAP.
01

Rubinetti e valvole a sfera per applicazioni speciali
Special applications bibcocks and ball valves

NEW



What's new?

Nuova famiglia di valvole a saracinesca PN 16.
New range of gate valves PN 16.

PAG. **43**

3994

CAP.
10

Raccordi generici in ottone
Brass fittings

NEW



What's new?

Prolunga cromata filettata maschio/maschio.
Chrome-plated extension male/male.

PAG. **157**

1531C

CAP.
10

Raccordi generici in ottone
Brass fittings

NEW



What's new?

Barilotto maschio/maschio cromato.
Male connector chrome plated.

PAG. **158**

1540C

CAP.
13

Raccordi a pressione per tubo multistrato "AL-COBRAPEX"
Press-fittings for multilayer pipe "AL-COBRAPEX"

NEW



What's new?

Ampliata la gamma di raccordi a pressione serie 1650 con l'inserimento di varie figure per tubo Ø 90 mm
The range of series 1650 press fittings has been widened with the addition of various shapes for 90mm pipes.

PAG. **198**

PAG. **199**

PAG. **200**

PAG. **202**

PAG. **209**

1650 - 1651 - 1652 - 1653 - 1657 - 1659 - 1661

CAP. 13

Raccordi a pressione per tubo multistrato "AL-COBRAPEX"
Press-fittings for multilayer pipe "AL-COBRAPEX"

NEW



What's new?

Staffa e raccordi 105° terminali COBRAFIX - Interasse 55mm
105° End fittings with bracket COBRAFIX - Distance between centers 55mm

PAG. 207

1664CG55

CAP. 18

Collettori di distribuzione "NINO" con valvole a sfera
"NINO" distribution manifolds with ball valves

NEW



What's new?

Ampliata la serie di collettori "NINO" con l'inserimento dei collettori da 3/4" a 2, 3 e 4 vie con uscite 1/2" tenuta piana ed interasse 50 mm.
Widening of the "NINO" manifolds range with the addition of 3/4" manifolds with 2,3 and 4 ways 1/2" flat seat and distance between centres 50 mm.

PAG. 292

1822RCP50

CAP. 18

Collettori di distribuzione "MAXIMA" con rubinetti d'arresto
"MAXIMA" distribution manifolds with stop cocks

NEW



What's new?

Completata la serie di collettori "MAXIMA" a 3/4" e 1" interasse 36 mm con l'inserimento del modello a 6 vie.
Completion of the "MAXIMA" manifolds range with 3/4" and 1", distance between centres 36 mm and addition of the 6 ways model.

PAG. 294

1866K - 1868K - 1877K36

CAP. 19

Valvole e distributori
Special valves

NEW



What's new?

Valvola termostattizzabile a squadra mono/bitubo cromata "DUAL" con ingresso acqua reversibile e sonda metallica L= 15 cm.
Angle chrome-plated single/double pipe thermostatic option valve "DUAL" with reversable flow inlet and metallic probe L= 15 cm.

PAG. 361

3381K

CAP. 19

Valvole e distributori
Special valves

NEW



What's new?

Nuove valvole termostattizzabili compatte mono/bitubo cromate con sonda L= 15 cm.
New compact chrome plated thermostatic valves mono/bi tube with probe L= 15 cm.

PAG. 362

3384K - 3386K

CAP. 19

Valvole e distributori
Special valves

NEW



What's new?

Valvola a squadra termostattizzabile nichelata con attacco per tubo rame, pex e multistrato.
Nickel-plated angle valve with thermostatic option, straight fitting and copper / PEX / multilayer pipe connection.

PAG. 364

3365N

CAP.
19

Comandi termostatici
Thermostatic controls

NEW



What's new?

Servocomando elettrotermico specifico per valvole radiatori termostattizzabili e collettori in poliammide.

Thermal drive specific for thermic radiator valves and polyamide manifolds.

9568

PAG. 351
PAG. 403

CAP.
20

Coppia collettori "FLOOR" in ottone stampato
"FLOOR" couple of forged brass manifolds

NEW

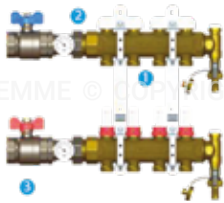

What's new?

Realizzazione di una nuova famiglia di collettori premontati modulari da 1"1/4 in ottone stampato con uscite 3/4"x18 (Eurocono). Da 2 a 12 vie con flussimetri o vitoni a memoria meccanica.

Introduction of a new family range of pre-assembled manifolds of 1"1/4 in printed brass with 3/4"x18 (Euroconus) ways. From 2 to 12 ways with flowmeters or mechanical memory screws.

3877 - 3877BY - 3879 - 3879BY

PAG. 371

CAP.
22

Valvole di bilanciamento
Balancing valves

NEW



What's new?

Nuova famiglia di valvole di bilanciamento dinamiche con controllo di pressione differenziale per colonne montanti.

New family range of dynamic balancing valves with differential pressure control for riser columns.

6538

PAG. 430

CAP.
22

Valvole di bilanciamento
Balancing valves

NEW



What's new?

Nuova famiglia di valvole di bilanciamento statiche con attacco per tubo capillare.

New family range of static balancing valves with attachment for capillary pipe.

6539

PAG. 430

CAP.
22

Valvole di bilanciamento
Balancing valves

NEW



What's new?

Nuova famiglia di valvole di bilanciamento dinamiche con controllo di pressione differenziale e comando ON-OFF.

New family range of dynamic balancing valves with differential pressure control and ON-OFF switch.

6540 - 9566

PAG. 430

CAP.
22

Filtri defangatori magnetici
Magnetic dirt separator filters

NEW



What's new?

Filtro magnetico sotto-caldiaia senza valvola a sfera e raccordo.

Under-boiler magnetic filter without ball valve and fitting.

3147

PAG. 431

CAP.
22

Disconnettori
Back flow preventers

NEW



What's new?

Disconnettori a zona di pressione ridotta controllabile di tipo BA da 1/2" a 2".
BA type adjustable reduced pressure zone disconnecter from 1/2" to 2".

PAG. **434**

3501

CAP.
22

Riduttori di pressione
Pressure reducing valves

NEW



What's new?

Completata la serie di riduttori PN25 con la versione con attacchi a bocchettoni Maschio/Maschio.

Completion of the adapters PN25 range with the addition of the version with male/male tail piece.

PAG. **437**

3108N

CAP.
22

Valvole deviatrici
Diverter valves

NEW



What's new?

Valvola termostatica a 3 vie deviatrice/miscelatrice con comando a pistone.
3 ways diverting/mixing thermostatic valve with piston control.

PAG. **440**

3890VD - 3890VDKIT

CAP.
22

Valvole deviatrici
Diverter valves

NEW



What's new?

Testa termostatica con sonda a distanza per valvola deviatrice/ miscelatrice.
Thermostatic head with remote probe for diverter/ mixing valve.

PAG. **440**

3890TTVD

CAP.
22

Collettore portastrumenti INAIL
INAIL tool-holding manifold

NEW



















































































What's new?

Collettore portastrumenti INAIL completo di strumentazione.
INAIL tool-holding manifold.

PAG. **451**

7169

CERTIFICAZIONI / CERTIFICAÇÕES

		ITALY RINA REGISTRO NAVALE ITALIANO			UKRAINE ORGANO DI CERTIFICAZIONE CCV "TYSK"
		ITALY POLITECNICO DI MILANO FONDAZIONE LABORATORIO PROVE MATERIE PLASTICHE			SLOVAKIA TECHNICKY SKUSOBNY USTAV
		ITALY ISTITUTO GIORDANO			CZECH REPUBLIC VYZKUMNY USTAV POZEMNICH STAVEB – CERTIFIKACNI SPOLECNOST S.R.O.
		ITALY CONSOZIO PASCAL			CZECH REPUBLIC STROJIRENSKY ZKUŠEBNI ÚSTAV
		GERMANY DEUTSCHER VEREIN DES GAS-UND WASSERFACHES			RUSSIA NASTHOL CERTIFICATION CENTERE CC
		DENMARK ETA - DANISH BOARD OF EUROPEAN TECHNICAL APPROVAL FOR CONSTRUCTION PRODUCTS			RUSSIA HYGIENE CERTIFICATE
		DENMARK CERTIFIKAT 03-00012			RUSSIA EAC CERTIFICATE
		DENMARK DTI ENERGY DANSK TEKNOLOGISK INSTITUT			POLAND PANSTWOWY ZAKLAD HIGIENY NATIONAL INSTITUTE OF HYGIENE
		NORWAY NORWEGIAN BUILDING RESEARCH INSTITUTE			POLAND INSTYTUT TECHNIKI BUDOWLANES
		SWEDEN SWEDISH INSTITUTE FOR TECHNICAL APPROVAL IN CONSTRUCTION			HUNGARY EPITESUGYI MINOSEGELLENORZO INTEZET INSTITUT FOR QUALITY CONTROL OF BUILDING
		FINLAND YMPÄRISTÖMINISTERIÖN TYYPPIHYVÄKSYNTAPÄÄTÖS THE FINNISH MINISTRY OF ENVIRONMENT			UNITED KINGDOM BRITISH GAS TECHNOLOGY
		SPAIN AENOR			UNITED KINGDOM WATER REGULATION ADVISORY SCHEME
		HOLLAND CENTRUM VOOR GASTECHNOLOGIE			FRANCE LABORATOIRE SANTÉ ENVIRONNEMENT HYGIÈNE DE LYON
		HOLLAND CERTIFICATIE EN KEURINGEN			FRANCE CENTRE SCIENTIFIQUE ET TECHNIQUE DU BÂTIMENT
		PORTUGAL ASSOCIAÇÃO PARA A CERTIFICAÇÃO DE PRODUTOS			FRANCE CENTRE SCIENTIFIQUE ET TECHNIQUE DU BÂTIMENT
		ROMANIA AGREMENT TEHNIC ÎN CONSTRUCTII ROMÂNIA			IRELAND IRISH AGREEMENT BOARD BUILDING PRODUCT CERTIFICATION
		BULGARIA TÜV RHEINLAND BULGARIA LTD.			SERBIA UVERENJE O KONTROLISANJU INSTITUT "MIHAJLO PUPIN" BEOGRAD
		AUSTRALIA WATERMARK LICENCE			EUROPE MARCHIO CE DI PRODOTTO
		AUSTRALIA OCEANA MARK			VIETNAM TESTING CENTER 3
		BELGIUM UNIVERSITÉ LIBRE DE BRUXELLES			SOUTH AFRICA AENOR

1 VALVOLE A SFERA E RUBINETTI IN OTTONE - PER ACQUA E PER GAS

BALL VALVES AND BRASS BIBCOCKS - FOR WATER AND GAS



2 RACCORDI A COMPRESSIONE PER TUBO RAME CON OGIVA IN OTTONE - SERIE 1000/1100

COMPRESSION FITTINGS FOR COPPER PIPE WITH BRASS RING - 1000/1100 SERIES



3 RACCORDI, VALVOLE E COLLETTORI IN OTTONE CW602N

CW602N BRASS-FITTINGS, VALVES AND MANIFOLDS



4 RACCORDI A COMPRESSIONE PER GAS CON OGIVA IN OTTONE - SERIE 1150

COMPRESSION FITTINGS WITH BRASS RING FOR GAS - 1150 SERIES



5 RACCORDI A COMPRESSIONE PER TUBO RAME CON OGIVA P.T.F.E. - SERIE 1200

COMPRESSION FITTINGS FOR COPPER PIPE WITH P.T.F.E. RING - 1200 SERIES



6 RACCORDI A COMPRESSIONE PER TUBO RAME CON TENUTA O-RING - SERIE 1300/1350

COMPRESSION FITTINGS FOR COPPER PIPE WITH O-RING - 1300/1350 SERIES



7 RACCORDI A COMPRESSIONE PER TUBO PEX "COBRAPEX" - SERIE 1400

COMPRESSION FITTINGS FOR PEX PIPE "COBRAPEX" - 1400 SERIES



8 RACCORDI A PRESSARE PER TUBO PEX "COBRAPEX" - SERIE 1700

PRESS-FITTINGS FOR PEX PIPE "COBRAPEX" - 1700 SERIES



9 RACCORDI A COMPRESSIONE CON O-RING PER TUBO PE/PEHD/PEX "COBRARING" - SERIE 3460

COMPRESSION FITTINGS WITH O-RING FOR POLYETHYLENE PIPE - 3460 "COBRARING" SERIES



10 RACCORDI GENERICI IN OTTONE - SERIE 1500

BRASS GENERIC FITTINGS - 1500 SERIES



11 RACCORDI UNIVERSALI PER TUBI RAME, PEX E MULTISTRATO - SERIE "WATERBLOCK"

COMPRESSION FITTINGS FOR COPPER, PEX AND MULTILAYER PIPES - "WATERBLOCK" - SERIES



12 RACCORDI A COMPRESSIONE PER TUBO MULTISTRATO "AL-COBRAPEX" - SERIE 1600

COMPRESSION FITTINGS FOR MULTILAYER PIPE "AL-COBRAPEX" - 1600 SERIES



13 RACCORDI A PRESSARE PER TUBO MULTISTRATO "AL-COBRAPEX" - SERIE 1650/2650

PRESS-FITTINGS FOR MULTILAYER PIPE "AL-COBRAPEX" - 1650/2650 SERIES



14 RACCORDI A PRESSATURA ASSIALE PER TUBO PEX "COBRAPEX" - SERIE 3400 "ASSIALPEX"

AXIAL PRESS FITTINGS FOR PEX PIPE "COBRAPEX" - 3400 "ASSIALPEX" SERIES



15 RACCORDI A SILDARE IN RAME E BRONZO

COPPER AND BRONZE SOLDERING FITTINGS



16 RACCORDI E TUBO IN POLIPROPILENE RANDOM BLU/VERDE

BLUE/GREEN POLYPROPYLENE PIPING SYSTEMS



17 TUBO IN POLIETILENE RETICOLATO "COBRAPEX" E MULTISTRATO "AL-COBRAPEX"

CROSS-LINKED POLYETHYLENE "COBRAPEX" PIPE AND "AL-COBRAPEX" MULTILAYER PIPE



18 COLLETTORI DI DISTRIBUZIONE

MANIFOLDS



19 VALVOLE PER RADIATORI

RADIATOR VALVES



20 COLLETTORI ED ACCESSORI PER IMPIANTI RADIANTI

MANIFOLDS AND ACCESSORIES FOR UNDERFLOOR HEATING SYSTEM



21 CONTROLLI DI TEMPERATURA

TEMPERATURE CONTROLS



22 COMPONENTI PER CENTRALI TERMICHE

COMPONENTS FOR CENTRAL HEATING



23 COMPONENTI PER IMPIANTI SOLARI TERMICI

COMPONENTS FOR SOLAR THERMAL SYSTEMS



24 GUIDA ALLE CONNESSIONI E AL MONTAGGIO

CONNECTION AND MOUNTING GUIDE



ART	PAG	ART	PAG	ART	PAG	ART	PAG	ART	PAG	ART	PAG
163BOX1	121	0660	223	1014C	84	1105N	67	1143	73	1250	98
163BOX1	178	0660	272	1014N	72	1106	68	1144	74	1250FP	98
0200B	284	0660B	223	1015	71	1106CZ	81	1145	74	1251	98
0200BL	284	0660B	272	1015	82	1106CZC	81	1147	74	1252	99
0200R	284	0660S	223	1015	469	1106N	68	1147	469	1253	99
0230B	284	0660S	272	1018CCZ	84	1107	69	1147CZ	74	1254	100
0230R	284	0670B	224	1018GCZ	84	1107	469	1147CZ	83	1255	100
0300B	280	0670B	273	1035	70	1107CZ	81	1149CCZ	84	1256	100
0300BB	280	0670R	224	1035	469	1107CZC	82	1149CCZ	339	1257	101
0300BL	282	0670R	273	1035N	71	1107N	69	1149GCZ	85	1259	101
0300N	281	0700X	473	1037	72	1108	68	1150	94	1290	309
0300NB	281	0705COL	474	1037N	72	1109	69	1151	94	1290N	176
0300R	282	0720X	473	1039	73	1109CZ	82	1152	94	1300	106
0316B	281	0800B	283	1039	469	1109N	70	1153	94	1301	106
0330B	280	0800R	283	1039J	471	1110	70	1154	95	1302	106
0330R	280	0805B	285	1039N	74	1110CZ	82	1155	95	1303	106
331G	343	0805R	285	1039S	471	1110N	71	1157	95	1304	106
331GKIT	352	0810B	283	1040S	471	1113KB	471	1159	95	1305	107
331GKIT01	352	0810R	283	1040T	472	1114	71	1161	96	1306	107
331H	343	0900B	225	1100	62	1114	82	1162	95	1307	107
331HKIT	352	0900B	274	1100CZ	78	1114	470	1163	95	1309	107
331HKIT01	352	0900B	285	1100CZC	78	1114C	84	1200	98	1314	108
332G	343	0900G	232	1100FD	63	1114N	72	1200FP	98	1315	108
332GKIT	353	0900G	274	1100FD	468	1115	72	1201	98	1316	108
332GKIT01	352	0900R	225	1100N	63	1115	82	1202	99	1317	108
332H	343	0900R	274	1101	63	1115	469	1203	99	1350	110
332HKIT	353	0900R	285	1101	468	1116	71	1204	99	1351	110
332HKIT01	352	1000	62	1101CZ	78	1116	107	1205	100	1352	110
0600	223	1000N	62	1101CZC	79	1116	470	1206	100	1353	110
0600	272	1001	63	1101N	64	1116CZ	83	1207	100	1354	110
0600B	223	1001	468	1102	64	1117FD	472	1209	101	1355	111
0600B	272	1001N	64	1102CZ	79	1118	472	1210	101	1356	111
0600G	232	1002	64	1102CZC	79	1119FD	472	1214	101	1357	111
0600G	274	1002N	65	1102FD	65	1120	72	1215	101	1359	111
0600GB	232	1003	65	1102FD	468	1120CZ	83	1220	161	1364	111
0600GB	274	1003	468	1102N	65	1130CZ	307	1230	102	1365	111
0615B	224	1003N	66	1103	65	1130CZ	88	1233	102	1367H	112
0615B	273	1004	66	1103	468	1133	65	1233	332	1400	114
0625	224	1004N	66	1103CZ	80	1133	117	1233N	332	1400AD	119
0625	273	1005	67	1103CZC	80	1133	469	1235	102	1401	115
0630B	223	1005	468	1103N	66	1135	70	1235	332	1401AD	119
0630B	272	1005N	67	1104	66	1135	469	1235N	332	1402	114
0630R	223	1007	68	1104CZ	80	1135CZ	83	1240C	349	1402AD	120
0630R	272	1007	469	1104CZC	81	1135N	71	1240K	332	1403	115
0635	224	1007N	69	1104FD	67	1138	70	1240N	179	1403AD	120
0635	273	1009	68	1104FD	468	1138	117	1240N	332	1404	115
0640B	224	1009N	70	1104N	67	1138	470	1241K	335	1404AD	120
0640B	273	1010	70	1104SW	79	1139	73	1241N	180	1405	116
0640G	232	1010N	70	1105	67	1139	469	1241N	335	1405AD	120
0640G	274	1014	71	1105	468	1140	74	1243K	337	1406	116
0640R	224	1014	82	1105CZ	80	1141	73	1248CZ	85	1406AD	120
0640R	273	1014	470	1105CZC	81	1142	74	1249CZ	85	1407	116

■ Nuovo prodotto / New product

ART	PAG	ART	PAG	ART	PAG	ART	PAG	ART	PAG	ART	PAG
1407AD	120	1481	107	1517	172	1557SET	400	1584C	170	1643GN	177
1408	117	1481	122	1518	172	1560	164	1585C	170	1644	176
1409	117	1481	127	1519	172	1560C	164	1590	173	1644GN	177
1409AD	120	1481	235	1520	172	1560CT	154	1591	173	1645	176
1410	117	1481	270	1521CP	158	1560CZ	90	1592	173	1645GN	177
1411	115	1490	121	1522	157	1560CZC	90	1600	184	1646GN	178
1412	116	1490P43	121	1530	156	1560N	164	1600OR	184	1647GN	178
1415	118	1491	121	1530C	157	1561	164	1601	184	1649	176
1415AD	120	1491	178	1530CZ	89	1561C	165	1601KB	189	1649GN	178
1416	118	1492MP	122	1531C ■	157	1561CT	154	1602	185	1649YGN	176
1416AD	120	1493SET	216	1540	158	1561CZ	90	1602	426	1650	198
1420K	122	1493Z	235	1540C ■	158	1561CZC	90	1603	185	1650CT	196
1420K (PEX)	122	1495	235	1541	157	1561DIN	165	1604	185	1650DR	217
1420P	122	1495	270	1543	158	1561N	164	1605	186	1651	198
1420P	129	1495	278	1550	159	1562	165	1606	186	1651CT	196
1420Z	122	1495	286	1550C	159	1562CZ	90	1607	186	1651CY	210
1420Z	129	1495R63	270	1550CT	154	1562N	165	1608	187	1651CYDR	221
1428MP	118	1495R63	286	1550CZ	89	1563	166	1609	187	1651DR	217
1428XL	118	1496	235	1550N	159	1563N	166	1610	187	1651FS	211
1431	73	1496	278	1551	160	1564FD	470	1611	189	1651KB	211
1431	339	1496	286	1551	306	1565	166	1612C	188	1651KBDR	221
1433K	337	1496R42	270	1551C	160	1565CP	167	1613C	188	1652	199
1435	332	1496R42	286	1551FD	161	1565N	166	1614BP	188	1652	426
1435K	333	1497	238	1551FD	471	1565NR	166	1615BP	188	1652CT	196
1435N	179	1497	277	1551N	159	1565R	166	1619	187	1652DR	218
1435N	333	1497EST	238	1552	160	1567	167	1620	188	1653	199
1436	335	1497EST	277	1552C	161	1568BOX	59	1626	186	1653CT	196
1436	387	1498MT	239	1552CZ	89	1568BOX	233	1631CZ	339	1653DR	218
1436K	335	1498MT	277	1552FD	426	1570	168	1631CZ	85	1653KB	211
1436N	180	1498SET	238	1552FD	470	1570	440	1631G	339	1654	199
1436N	335	1498SET	277	1552FD	160	1570C	167	1631G	73	1654CT	196
1436N	387	1498UM	238	1552FD	306	1570CT	154	1631GCZ	85	1654DR	218
1436N06	315	1498UM	277	1552FDR	470	1570CZ	90	1632K	297	1655	200
1436N06	386	1498US	239	1552FDR	161	1570CZC	91	1633K	338	1655CT	197
1450	118	1498US	277	1552N	161	1570N	167	1635	333	1655DR	218
1450	310	1500	155	1552SET	473	1571	167	1635C	349	1656	202
1460	145	1501	155	1552XL	161	1571N	167	1635K	333	1656CE	202
1461	145	1502	171	1553FD	470	1572	168	1635N	179	1656DFCT	197
1462	145	1503	171	1553FD	162	1572FD	168	1635N	333	1656DR	220
1463	145	1504	172	1555	162	1572FD	470	1636	336	1656ISOL01	202
1464	145	1505C	364	1555CP	162	1572N	168	1636	387	1656ISOL02	203
1465	145	1505C04	122	1555N	162	1574	168	1636K	336	1656KB	203
1467	145	1505C04	129	1555NR	163	1580	168	1636N	180	1656SM	202
1468	145	1507	155	1555R	162	1580N	169	1636N	336	1656SMDR	220
1469	145	1508	155	1555SET	163	1581	169	1636N	387	1656XL	203
1475	140	1510	156	1555SET	400	1581C	170	1636N06	181	1657	200
1475	143	1511	156	1555U	162	1581CZ	89	1638GN	178	1657CT	197
1475	147	1513	156	1557	163	1581FD	169	1640	176	1657DR	219
1476	143	1513	322	1557CP	163	1581FD	471	1640GN	177	1658	201
1476	189	1514	156	1557N	163	1581N	170	1641GN	177	1658DR	219
1480P	286	1514	322	1557SET	413	1582	170	1642	176	1659	202
1481	102	1516	172	1557SET	163	1583	170	1642GN	177	1659CT	197

■ Nuovo prodotto / New product

ART	PAG	ART	PAG	ART	PAG	ART	PAG	ART	PAG	ART	PAG
1659DR	220	1681	276	1695TM02C	275	1829Z	367	1880	321	1916	448
1660	216	1681MINI	237	1696	25	1832	291	1880N	171	1917	445
1660BP	206	1681MINI	275	1696	214	1832RCP	291	1881	321	1917M	446
1661	209	1681MINIRF	133	1697	24	1842	293	1881	426	1917MAN	447
1661DR	221	1681MINIRF	286	1697	213	1859	180	1882	321	1917SUN	460
1662	206	1681RF	133	1697CK	24	1859	211	1883	305	1918	446
1662CG	206	1681RF	286	1697CK	213	1859	315	1884	305	1918MAN	447
1662DR	221	1682	235	1699	235	1859	336	1885	305	1919	450
1662LG	206	1682	278	1700	126	1859	338	1886	320	1920	326
1663	208	1683	236	1701	126	1859	386	1887	320	1921OG	449
1663DI	208	1683	278	1701R	126	1859	426	1889R	321	1921OM	449
1664	207	1684	238	1702	126	1863	314	1889TERMO	386	1921OP	449
1664CG	206	1684	277	1703	127	1864	314	1890	320	1922	303
1664CG55 ■	207	1685M	237	1704	127	1864	327	1890R	321	1922CP	305
1664DI	208	1685M	276	1705	127	1864P	399	1892	176	1922SH	304
1665	204	1685US	238	1706	127	1864P	327	1892	322	1923	450
1665	414	1685US	276	1707	127	1865	327	1895	306	1923FL	450
1665	426	1687	210	1707R	128	1865	386	1896	323	1924	450
1665	426	1688	210	1709	128	1866	299	1896	443	1927	445
1665DR	220	1689	238	1710	129	1866G16SH	296	1896GG	323	1927M	446
1666	180	1689	276	1715	128	1866K	294	1896GG	443	1927MAN	447
1666	205	1690	24	1716	129	1866SH	296	1897	321	1927SUN	460
1666	337	1690	215	1716	179	1868	299	1898	323	1928	446
1666DR	220	1690U	24	1716	181	1868G16SH	296	1898	443	1928MAN	447
1666K	338	1690U	214	1716	333	1868K	294	1899	324	1929	450
1666K	205	1691	25	1716	336	1868SH	296	1899	443	1930	326
1667	205	1691	213	1716	338	1870	327	1900	323	1931	326
1668	179	1692	24	1716K	338	1871K	297	1900	443	1932	307
1668	205	1692	213	1718	129	1872	48	1900G	323	1935	436
1668	334	1692CK	24	1720X	132	1872	320	1900G	443	1939	325
1668DR	221	1692CK	213	1730	129	1874	59	1900G34	324	1939	374
1669	206	1693	216	1735	130	1874	234	1900G34	444	1939	384
1669DR	221	1693PR	216	1736	130	1874PL	59	1900KITSUN	472	1940	326
1670B	132	1694	206	1740	131	1874PL	234	1900N34	324	1941	386
1670X	212	1694	339	1740U	132	1876K	298	1900N34	444	1942	307
1671	210	1695TM01	133	1746	132	1876K50	298	1900SUN	460	1952	308
1672	209	1695TM01	236	1800	325	1877K36	294	1901	323	1953	308
1672CY	209	1695TM01	275	1801	290	1877K50	295	1901	444	1954	308
1673	209	1695TM01B	133	1802	290	1877K50	295	1902	322	1962	308
1674	211	1695TM01B	236	1802G16SH	290	1877SKIT	328	1903	322	1963	308
1675	210	1695TM01B	275	1804	290	1878	171	1904	322	1964	308
1675ISOL	210	1695TM01C	133	1805	327	1878	320	1905	301	1975	309
1676	204	1695TM01C	236	1807	326	1878	471	1905G16SH	301	1976	309
1676KB	204	1695TM01C	275	1808	326	1878CZ	91	1906	301	1985	309
1676SM	203	1695TM02	133	1809	327	1878N	171	1908	302	1986	309
1676SMR	220	1695TM02	236	1810	325	1879	179	1909	302	1987	309
1677	211	1695TM02	275	1812	325	1879	180	1910P	325	2030CZ	27
1677DR	222	1695TM02B	133	1822	291	1879	216	1912	303	2030CZ	87
1678	208	1695TM02B	236	1822RCP	291	1879	333	1912CP	305	2070	320
1679KB	209	1695TM02B	275	1822RCP50 ■	292	1879	337	1912G16SH	304	2070	387
1681	134	1695TM02C	133	1822SH	293	1879K	338	1912R	303	2075	408
1681	237	1695TM02C	236	1828Z	426	1880	171	1912SH	304	2075KIT01	399

■ Nuovo prodotto / New product

ART	PAG	ART	PAG	ART	PAG	ART	PAG	ART	PAG	ART	PAG
2075KIT02	399	2153FLB	190	2220G	51	2360N	2	2570B	29	2940NCZ	31
2075KIT03	413	2153FLR	22	2220N	14	2360N07	11	2584	29	2941	35
2076	408	2153FLR	190	2220R	14	2360R07	11	2585C	30	2942	33
2077	408	2154B	22	2221G	51	2361	2	2585G	30	2942CZSL	32
2078	408	2154B	191	2221N	15	2361N	2	2586C	30	2942NCZ	31
2080	438	2154FLB	22	2221R	14	2361N07	11	2586G	30	2944	34
2080POST	447	2154FLB	191	2223G	56	2361R07	11	2588C	30	2944	192
2081	452	2154FLR	22	2224G	56	2370	2	2590	29	2944K	34
2082E	453	2154FLR	191	2225G	56	2370B	2	2595	48	2944K	192
2082KIT	453	2154R	22	2227	21	2370G07	50	2601G	53	2945	34
2082R	453	2154R	191	2230	15	2370N	2	2610	19	2945K	34
2091	47	2155B	23	2230V	16	2370N07	11	2621G	53	2946	35
2092	47	2155B	191	2230X	15	2370R07	11	2650	228	2947	34
2092LOCK	47	2155FLB	23	2231	15	2371	3	2651	228	2947K	35
2093G	60	2155FLB	191	2231V	16	2371B	3	2652	228	2948	39
2093LOCK	48	2155FLR	23	2232 ■	18	2371G07	50	2653	228	2949	39
2093R	47	2155FLR	191	2233 ■	18	2371N	3	2654	228	2950	39
2094	48	2155R	22	2240G	51	2371N07	12	2655	229	2953	39
2095R	426	2155R	191	2240P	15	2371R07	11	2656	230	2954	40
2096	48	2156B	23	2241G	51	2371SUN	460	2656SM	229	2956	39
2120R	21	2156B	192	2241P	15	2372	3	2657	229	2957	35
2120R	320	2156R	23	2250G	56	2372B	3	2658	229	2958	39
2120R	374	2156R	191	2251G	56	2380	3	2659	229	2959	39
2120R	383	2157B	23	2252G	56	2380B	3	2660BP	231	2960	42
2121	20	2157B	192	2253G	56	2380G07	50	2661	231	2960PR	43
2121CP	20	2157R	23	2260G	56	2380R07	12	2665	230	2960PR	131
2121R	20	2157R	192	2261G	56	2380X	4	2666	230	2960PR	215
2121R	319	2162SUN	460	2262G	56	2380XB ■	4	2670X	231	2960SET	42
2121R	374	2163	190	2263	26	2381	4	2676	230	2960SET	131
2121R	383	2180	20	2263CK	26	2381B	4	2676SM	230	2960SET	215
2132CZ	27	2180CP	20	2263G	57	2381G07	50	2677	231	2961	42
2132CZ	87	2180CPR	20	2266	26	2381R07	12	2691	57	2961SET	42
2133	36	2180CPR	319	2266CK	26	2382	4	2691	231	2961SET	131
2133	329	2181CPR	23	2266G	57	2382B	4	2692	57	2961SET	215
2134	36	2181CPR	190	2266N	26	2450N ■	9	2692	231	2962	48
2134	328	2181CPR	319	2266OT	27	2451N ■	9	2697	57	2963SET	42
2134SUN	461	2182	21	2270	16	2460N ■	9	2697	231	2963SET	131
2136	36	2182	319	2271 ■	16	2461N ■	9	2900	33	2963SET	215
2136	329	2182R	21	2310	6	2471N ■	9	2900NCZ	31	2964	41
2137	36	2182R	319	2310N	6	2472N ■	9	2901	33	2964Z	41
2137	329	2182R	374	2311	6	2510	28	2901NCZ	31	2965	43
2138	36	2182R	383	2311N	6	2510N	28	2902	33	2965PROL	43
2138	329	2183R	21	2320	6	2511B	29	2902CZ	31	2966	39
2139 ■	36	2183R	319	2320N	7	2520	28	2902NCZ	31	2967	42
2139 ■	328	2183R	374	2321	7	2520B	28	2910CZ	31	2970	43
2142	25	2183R	383	2321N	7	2530	29	2911CZ	31	2971SET ■	42
2143	22	2200G	51	2330	7	2530X	29	2912CZ	32	2971SET ■	131
2143	190	2201G	51	2330SUN	460	2530X316	29	2931	33	2971SET ■	215
2152	25	2210N	14	2331	7	2531V	29	2932	33	2980	26
2153	22	2210R	14	2331SUN	460	2535V	29	2940	33	2985	26
2153	190	2211N	14	2332	7	2560	28	2940CZ	32	2990G	43
2153FLB	22	2211R	14	2360	2	2570	29	2940CZSL	32	2990G	322

■ Nuovo prodotto / New product

ART	PAG	ART	PAG	ART	PAG	ART	PAG	ART	PAG	ART	PAG
2990G	388	3175CT	452	3307KIT04R	354	3400	244	3467DR	151	3701UPL	58
2991SUN	460	3175ISOL	452	3308	347	3401	244	3467W	139	3701UPL	233
3000X	463	3180	438	3308KIT03	353	3401R	244	3468	147	3855X	382
3001KB	463	3180C	439	3308KIT03R	354	3402	244	3468CR	142	3856	378
3001X	463	3200X	466	3308KIT04R	354	3403	245	3468W	139	3856I	379
3002X	464	3201KB	466	3312	345	3404	245	3469	147	3856X	381
3003KB	464	3201X	466	3313	345	3405	245	3469CR	142	3857	378
3004X	463	3202X	466	3320	357	3406	245	3469DR	151	3865X	382
3005X	464	3203KB	466	3321	357	3406L	246	3469W	139	3866	378
3007KB	463	3204X	466	3325	357	3407	245	3470CR	142	3866I	379
3011X	463	3205X	467	3326	357	3407R	246	3471CR	142	3866X	381
3030	310	3207KB	466	3330	348	3409	246	3471DR	151	3867	378
3031	310	3211X	466	3330C	350	3415	246	3472	143	3868G	397
3032	310	3220EXCEL	359	3331	348	3418	247	3472W	139	3868GHTPP2	397
3033	318	3221EXCEL	359	3331C	350	3422	247	3472W	147	3868GHTPP3	397
3035	318	3223EXCEL	359	3335	348	3423	247	3473	143	3871	376
3036	310	3225EXCEL	359	3335C	350	3447ESP	248	3473W	139	3871BY	375
3037	310	3226EXCEL	359	3336	348	3447PRES	248	3474	139	3872	376
3039	312	3227DX	345	3336C	350	3448B	248	3474	143	3872BY	375
3040	312	3227SX	345	3338	367	3448C	248	3475	140	3873	370
3042	312	3228DX	345	3339	321	3448ESP	248	3475	143	3873BY	370
3046	314	3228SX	345	3340	367	3448PRES	248	3475	148	3874	385
3047	314	3230EXCEL	360	3341	322	3449ESP	248	3477	147	3874P	315
3048	314	3231EXCEL	360	3342	367	3449PRES	248	3478	148	3874P	386
3049	372	3233EXCEL	360	3345N	368	3460	146	3491	151	3875	376
3049I	373	3235EXCEL	360	3350	368	3460CR	140	3493	151	3875BY	375
3049KIT01	372	3236EXCEL	360	3350	444	3460DR	150	3500	44	3876	376
3049KIT02	372	3260	358	3351	368	3460W	138	3501 ■	434	3877 ■	371
3049SKIT	328	3261	358	3351	444	3461	146	3505	44	3877BY ■	371
3049SKIT	399	3263	358	3352	368	3461CR	140	3505SUN	460	3878	370
3050	372	3265	358	3352	388	3461DR	150	3510	44	3878BY	370
3050I	373	3266	358	3352	444	3461W	138	3600	44	3879 ■	371
3053	315	3300	346	3353G	472	3462	146	3650	46	3879BY ■	371
3054	315	3300ATTR	368	3361K	364	3462CR	141	3651	46	3880GPF	413
3100N	437	3300C	349	3363K	364	3462DR	150	3660	45	3880GSM	413
3107N	437	3301	346	3365N ■	364	3462W	138	3665	45	3881	377
3108N ■	437	3301C	349	3370K	363	3463	146	3670	46	3881BY	377
3110N	437	3302	347	3371K	363	3463CR	141	3670	435	3885	377
3120N	433	3302KIT03	353	3375K	363	3463DR	150	3670CZISO7	46	3885BY	377
3130N	432	3302KIT03R	354	3376K	363	3463W	138	3670CZISO7	435	3887	400
3131N	432	3302KIT04R	355	3381K ■	361	3464	146	3675CZLOCK	28	3888	400
3135N	432	3303	347	3382K	361	3464CR	141	3675CZLOCK	87	3889	400
3136N	432	3303KIT03	353	3383K	361	3464DR	150	3701G	58	3890BV	389
3140	433	3303KIT03R	354	3383SOND ■	361	3464W	138	3701G	233	3890P	399
3145	433	3303KIT04R	355	3384K ■	362	3465	146	3701G1 ■	58	3890P	414
3146	431	3305	346	3385K	361	3465CR	141	3701G1 ■	233	3890PG3	459
3146OR	431	3305C	349	3386K ■	362	3465DR	150	3701PL	58	3890PG4	459
3147 ■	431	3306	346	3390RID	365	3465W	138	3701PL	233	3890PV	414
3148	431	3306C	349	3391	365	3466CR	141	3701PROL	59	3890PW2	399
3149	431	3307	347	3391BY	365	3466DR	151	3701PROL	234	3890PW2	414
3160K	439	3307KIT03	353	3393	365	3467	147	3701UG	58	3890PW4	459
3170	439	3307KIT03R	354	3393BY	365	3467CR	141	3701UG	233	3890PW5	414

■ Nuovo prodotto / New product

ART	PAG	ART	PAG	ART	PAG	ART	PAG	ART	PAG	ART	PAG
3890SKIT	327	4340FR	257	5090R	251	7165	428	H8996	320	R118B	264
3890SKIT	399	4341B	257	5092R	251	7165ISOL	428	H9300 ■	212	R118V	268
3890TTVD ■	440	4359B	257	5130R	252	7166	423	H9302	300	R119B	264
3890VD ■	440	4471B	257	5240R	253	7167	423	H9705	368	R120	270
3890VDKIT ■	440	4472B	257	5243R	254	7169 ■	451	H9706CAP	368	R122V	268
3891	379	4530	238	5270R	254	8930IM	473	H9706CV	368	R135B	264
3891BY	379	4530	276	5293R	258	8930SET	473	PCONT01	54	R135V	268
3891G0001	400	4601	356	5300R	255	9341SET	473	PCONT01SER	54	R400B	264
3891N	383	4601	405	5370R	258	9535	36	PCONT02	54	R400V	268
3891NBY	383	4606	405	5532HYBRID	427	9535	329	PCONT02SER	54	R500	270
3895G	389	4612	405	5532PDC	427	9536	37	PCONT03	54	R505B	270
3895I	390	4625D	402	5535DIFF	413	9536	329	PCONT03SER	54	R510	270
3895IHT	390	4730V	461	5535G	410	9537	36	PCONT04	54	R510MA	270
3895KCL	389	4731ANTIG	462	5535G3P	411	9537	329	PCONT04SER	54	R616	270
3895KHT	389	4735E	457	5535GPF	410	9550	367	PCONT05	55	R616NAS	172
3895KPF	389	4736SONDA	457	5536G	412	9551	351	PCONT05SER	55		
3896CL	395	4737GN	441	5536GS	412	9552	367	PCONT06	55		
3896CLBY	395	4737GNSUN	461	5537KIT	413	9552NX	367	PCONT07	55		
3896CLHT	395	4738	441	5538G2M3	415	9552P06	367	PCONT07SER	55		
3896CLHTBY	395	4738GN	441	5538G2M4	415	9553	350	PCONT08	55		
3896PF	393	4738GNSUN	461	5538G3M4	416	9553AM1	351	R100B	262		
3896PFBY	393	4738KIT	442	5538G3M6	416	9553AM2	351	R100V	266		
3896PFHT	393	4738KIT	461	5538G4M6	417	9553C	350	R101B	262		
3896PFHTBY	393	4738KIT01	441	5538G4M8	417	9553CHT	351	R101V	266		
3899G3	391	4738KIT01	461	5538X	428	9553INS	351	R102B	262		
3899G3BY	391	4738KR	442	5539X	428	9556	351	R102V	266		
3899G4	391	4738SUN	461	5540G2M4	418	9556USB	351	R103B	262		
3899G4BY	391	4739GN	441	5540G3M4	418	9556W	356	R103V	266		
3900C	40	4739GNSUN	461	5540G3M6	419	9558	351	R104B	262		
3901C	40	4741	462	5540G4M6	419	9561KIT01	399	R104V	266		
3902C	41	4744	457	5540G4M8	420	9561KIT02	413	R105B	262		
3903C	41	4745	456	5540G5M6	420	9561T	472	R105V	266		
3904C	41	4745C	459	5540G5M10	421	9562SERV	414	R106B	262		
3905C	41	4745E	456	5540G6M8	421	9566 ■	430	R106V	266		
3906C	40	4745MANOP	413	5540G6M12	422	9567	315	R107B	263		
3907C	40	4745MANOP	458	5540G7M8	422	9567	388	R107V	267		
3908C ■	39	4745R	457	5540G7M14	423	9567	399	R108B	263		
3909C ■	39	4746	461	5540X	428	9567	403	R108V	267		
3910	41	4746KIT	461	5906	259	9567G	403	R109B	263		
3911	41	4747	458	5907	259	9567KIT	315	R109V	267		
3912	41	4748D	458	5908	259	9567KIT	386	R111B	263		
3994 ■	43	4749E	458	5909	259	9568 ■	351	R111V	267		
3996L	43	4749FLOW	458	6535DN	429	9568 ■	403	R112B	263		
3997	41	4749FLOWE	458	6535DNISOL	429	9573	402	R112V	267		
4090B	255	5001R	250	6535DNMANOP	429	9574	402	R113B	263		
4092B	255	5002FR	257	6535ET	429	9575	402	R113V	267		
4096FR	255	5002R	250	6535G	429	9580	402	R114B	263		
4098B	255	5040R	251	6535ISOL	429	9580W	356	R114V	267		
4130B	256	5041R	251	6535PP	429	9581	402	R115B	264		
4243B	256	5060R	254	6538 ■	430	9582U	407	R115V	268		
4270B	256	5085R	250	6539 ■	430	9583CU	407	R117B	264		
4340B	256	5086R	250	6540 ■	430	9760	367	R117V	268		

■ Nuovo prodotto / New product



VALVOLE A SFERA E RUBINETTI IN OTTONE

BALL VALVES AND BRASS BIBCOCKS

Valvole e rubinetti per acqua

Valves and bibcocks for water

A

NEW

Valvole a sfera a passaggio standard e filettatura ISO 228 "MISTRAL"
"MISTRAL" standard bore ISO 228 thread ball valves

Valvole a sfera a passaggio totale e filettatura ISO 228 "SCIROCCO"
"SCIROCCO" full bore ISO 228 thread ball valves

Valvole a sfera a passaggio totale e filettatura ISO 228 "BURAN"
"BURAN" full bore ISO 228 thread ball valves

Valvole a sfera a passaggio standard e filettatura ISO 7 "TORNADO"
"TORNADO" standard bore ISO 7 thread ball valves

Valvole a sfera a passaggio totale e filettatura ISO 7 "URAGANO"
"URAGANO" full bore ISO 7 thread ball valves

Valvole a sfera a passaggio totale e filettatura ISO 7 "TIFONE"
"TIFONE" full bore ISO 7 thread ball valves

Valvole a sfera a passaggio totale per collettori
Full bore ball valves for manifolds

Valvole a sfera con attacchi a compressione o pressare
Compression or press-fitting connections ball valves

Valvole a sfera per acqua
Ball valves for water

Valvole a sfera in ottone antidezincificante CW 602N
CW 602N antidezincification brass ball valves

Valvole a sfera con filettatura ISO 7 in ottone antidezincificante CW 602N
CW 602N antidezincification brass ISO 7 thread ball valves

Rubinetti a sfera "EOLO"
"EOLO" ball bibcocks

Rubinetti con vitone
Bibcocks with stop cock

Mini valvole a sfera in ottone antidezincificante CW 602N cromate "SMALL"
"SMALL" CW 602N antidezincification brass chrome-plated mini ball valves

Mini valvole a sfera cromate "SMALL"
"SMALL" chrome-plated mini ball valves

Mini valvole a sfera "SMALL"
"SMALL" mini ball valves

Valvole a sfera motorizzate
Motorized ball valves

Rubinetti e valvole a sfera per applicazioni speciali
Special applications bibcocks and ball valves

Valvole di ritegno e di fondo
Check and foot valves

Filtri a Y
Strainer

Ricambi
Spare parts



2
6
9
11
14
19
20
25
26
27
28
28
30
31
33
34
36
39
44
46
47

**2360**

Femmina/femmina ISO 228 con
leva alluminio rossa
*Female/female ISO 228 with red
aluminium handle*

Codice Code	Tipo Size	Prezzo € Price €	Conf. Unit/Box
236 0010	1/2"		25/100
236 0007	3/4"		15/60
236 0005	1"		12/48
236 0008	1"1/4		8/32
236 0009	1"1/2		4/16
236 0004	2"		2/8

**2361N**

Maschio/femmina ISO 228 con
leva alluminio nera
*Male/female ISO 228 with black
aluminium handle*

Codice Code	Tipo Size	Prezzo € Price €	Conf. Unit/Box
236 0178	1/2"		25/100
236 0179	3/4"		15/60
236 0180	1"		12/48
236 0187	1"1/4		8/32
236 0188	1"1/2		4/16
236 0189	2"		2/8

**2360N**

Femmina/femmina ISO 228 con
leva alluminio nera
*Female/female ISO 228 with
black aluminium handle*

Codice Code	Tipo Size	Prezzo € Price €	Conf. Unit/Box
236 0175	1/2"		25/100
236 0176	3/4"		15/60
236 0177	1"		12/48
236 0184	1"1/4		8/32
236 0185	1"1/2		4/16
236 0186	2"		2/8

**2370**

Femmina/femmina ISO 228 con
leva farfalla rossa
*Female/female ISO 228 with red
T handle*

Codice Code	Tipo Size	Prezzo € Price €	Conf. Unit/Box
236 0002	1/2"		25/100
236 0003	3/4"		15/60
236 0012	1"		12/48
236 0035	1"1/4		8/32

**2361**

Maschio/femmina ISO 228 con
leva alluminio rossa
*Male/female ISO 228 with red
aluminium handle*

Codice Code	Tipo Size	Prezzo € Price €	Conf. Unit/Box
236 0015	1/2"		25/100
236 0019	3/4"		15/60
236 0014	1"		12/48
236 0023	1"1/4		8/32
236 0029	1"1/2		4/16
236 0026	2"		2/8

**2370N**

Femmina/femmina ISO 228 con
leva farfalla nera
*Female/female ISO 228 with
black T handle*

Codice Code	Tipo Size	Prezzo € Price €	Conf. Unit/Box
236 0190	1/2"		25/100
236 0191	3/4"		15/60
236 0192	1"		12/48
236 0193	1"1/4		8/32

**2370B**

Femmina/femmina ISO 228 con
leva farfalla blu
*Female/female ISO 228 with
blue T handle*

Codice Code	Tipo Size	Prezzo € Price €	Conf. Unit/Box
236 0060	1/2"		25/100
236 0061	3/4"		15/60
236 0136	1"		12/48
236 0137	1"1/4		8/32

**2371**

Maschio/femmina ISO 228 con
leva farfalla rossa
*Male/female ISO 228 with red
T handle*

Codice Code	Tipo Size	Prezzo € Price €	Conf. Unit/Box
236 0001	1/2"		25/100
236 0006	3/4"		15/60
236 0011	1"		12/48
236 0031	1"1/4		8/32

**2372B**

Maschio /maschio ISO 228 con
leva farfalla blu
*Male / male ISO 228 with blue
T handle*

Codice Code	Tipo Size	Prezzo € Price €	Conf. Unit/Box
236 0066	1/2"		25/100
236 0067	3/4"		15/60
236 0043	1"		12/48
236 0047	1"1/4		8/32

**2371N**

Maschio/femmina ISO 228 con
leva farfalla nera
*Male/female ISO 228 with black
T handle*

Codice Code	Tipo Size	Prezzo € Price €	Conf. Unit/Box
236 0182	1/2"		25/100
236 0183	3/4"		15/60
236 0181	1"		12/48
236 0194	1"1/4		8/32

**2380**

Femmina/femmina con leva
acciaio piatta plastificata rossa
*Female/female with red steel
flat handle*

Codice Code	Tipo Size	Prezzo € Price €	Conf. Unit/Box
236 0017	1/2"		25/100
236 0016	3/4"		15/60
236 0013	1"		12/48
236 0021	1"1/4		8/32
236 0027	1"1/2		4/16
236 0018	2"		2/8

**2371B**

Maschio/femmina ISO 228 con
leva farfalla blu
*Male/female ISO 228 with blue
T handle*

Codice Code	Tipo Size	Prezzo € Price €	Conf. Unit/Box
236 0063	1/2"		25/100
236 0064	3/4"		15/60
236 0125	1"		12/48
236 0138	1"1/4		8/32

**2380B**

Femmina/femmina con leva
acciaio piatta plastificata blu
*Female/female with blue steel
flat handle*

Codice Code	Tipo Size	Prezzo € Price €	Conf. Unit/Box
236 0045	1/2"		25/100
236 0068	3/4"		15/60
236 0124	1"		12/48
236 0128	1"1/4		8/32
236 0129	1"1/2		4/16
236 0130	2"		2/8

**2372**

Maschio /maschio ISO 228 con
leva farfalla rossa
*Male / male ISO 228 with red T
handle*

Codice Code	Tipo Size	Prezzo € Price €	Conf. Unit/Box
236 0032	1/2"		25/100
236 0038	3/4"		15/60
236 0040	1"		12/48
236 0048	1"1/4		8/32

**2380X**

Femmina/femmina con leva acciaio inossidabile piatta plastificata rossa
Female/female with red stainless steel flat handle

Codice Code	Tipo Size	Prezzo € Price €	Conf. Unit/Box
236 0115	1/2"		25/100
236 0116	3/4"		15/60
236 0117	1"		12/48
236 0118	1"1/4		8/32
236 0119	1"1/2		4/16
236 0120	2"		2/8

**2381B**

Maschio/femmina con leva acciaio piatta plastificata blu
Male/female with blue steel flat handle

Codice Code	Tipo Size	Prezzo € Price €	Conf. Unit/Box
236 0123	1/2"		25/100
236 0131	3/4"		15/60
236 0132	1"		12/48
236 0133	1"1/4		8/32
236 0134	1"1/2		4/16
236 0135	2"		2/8

**2380XB**

Femmina/femmina con leva acciaio inossidabile piatta plastificata blu
Female/female with blue stainless steel flat handle

Codice Code	Tipo Size	Prezzo € Price €	Conf. Unit/Box
236 0220	1/2"		25/100
236 0223	3/4"		15/60
236 0221	1"		12/48
236 0224	1"1/4		8/32
236 0222	1"1/2		4/16
236 0225	2"		2/8

**2382**

Maschio/maschio con leva acciaio piatta plastificata rossa
Male/male with red steel flat handle

Codice Code	Tipo Size	Prezzo € Price €	Conf. Unit/Box
236 0039	1/2"		25/100
236 0037	3/4"		15/60
236 0041	1"		12/48
236 0042	1"1/4		8/32

**2381**

Maschio/femmina con leva acciaio piatta plastificata rossa
Male/female with red steel flat handle

Codice Code	Tipo Size	Prezzo € Price €	Conf. Unit/Box
236 0028	1/2"		25/100
236 0030	3/4"		15/60
236 0024	1"		12/48
236 0034	1"1/4		8/32
236 0036	1"1/2		4/16
236 0033	2"		2/8

**2382B**

Maschio/maschio con leva acciaio piatta plastificata blu
Male/male with blue steel flat handle

Codice Code	Tipo Size	Prezzo € Price €	Conf. Unit/Box
236 0087	1/2"		25/100
236 0088	3/4"		15/60
236 0044	1"		12/48
236 0046	1"1/4		8/32

DIMENSIONI
DIMENSIONS

TABELLA DIMENSIONI / DIMENSION TABLE

Dimensione Size	1/2"	3/4"	1"	1"1/4	1"1/2	2"
Ø (DN)	14	18	23,5	30	37,5	47
A	85	85	100	100	140	140
A 2370	50	50	65	65	-	-
A 2380	85	85	113	113	141	141
B	48	52,5	59,5	64,5	76	89
ØC	27,5	33,5	42	53	64	79
E	11	11	14	15	16	17,5
L	45	52,5	64	74	85	98
Em	10	10	13	14	15	16,5
Lm/f	51,5	57,5	68,5	81	92	107
Lm/m	50	55,5	66,5	79	-	-
PN	30	30	30	25	25	25

Tutte le dimensioni (ad eccezione del PN) sono espresse in mm / All dimensions (except for PN) are in mm

**2310**

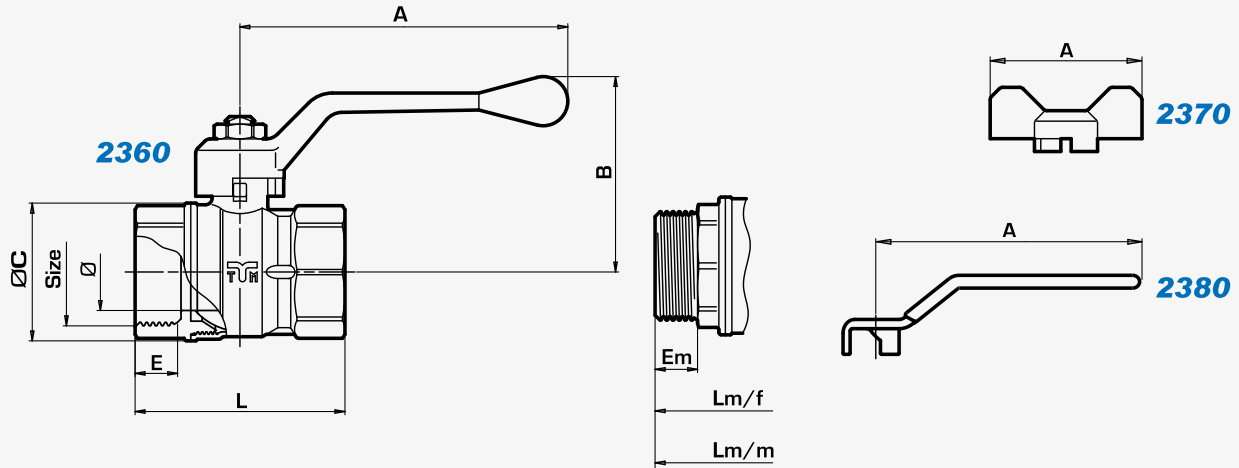
Femmina/femmina ISO 228 con
leva alluminio rossa
*Female/female ISO 228 with red
aluminium handle*

Codice Code	Tipo Size	Prezzo € Price €	Conf. Unit/Box
231 0045	ISO 7 1/4"		25/100
231 0034	ISO 7 3/8"		25/100
231 0002	1/2"		20/80
231 0008	3/4"		15/60
231 0001	1"		10/40
231 0005	1"1/4		4/16
231 0009	1"1/2		3/12
231 0004	2"		2/8
231 0037	2" 1/2		1/4
231 0021	3"		1/3
231 0027	4"		1/1

**2310N**

Femmina/femmina ISO 228 con
leva alluminio nera
*Female/female ISO 228 with
black aluminium handle*

Codice Code	Tipo Size	Prezzo € Price €	Conf. Unit/Box
231 0145	ISO 7 1/4"		25/100
231 0059	ISO 7 3/8"		25/100
231 0146	1/2"		20/80
231 0147	3/4"		15/60
231 0148	1"		10/40
231 0149	1"1/4		4/16
231 0150	1"1/2		3/12
231 0151	2"		2/8
231 0152	2" 1/2		1/4
231 0153	3"		1/3
231 0154	4"		1/1

**2311**

Maschio/femmina ISO 228 con
leva alluminio rossa
*Male/female ISO 228 with red
aluminium handle*

Codice Code	Tipo Size	Prezzo € Price €	Conf. Unit/Box
231 0054	1/4"		25/100
231 0041	3/8"		25/100
231 0013	1/2"		25/100
231 0014	3/4"		10/40
231 0011	1"		10/40
231 0018	1"1/4		4/16
231 0025	1"1/2		3/12
231 0023	2"		2/8

**2311N**

Maschio/femmina ISO 228 con
leva alluminio nera
*Male/female ISO 228 with black
aluminium handle*

Codice Code	Tipo Size	Prezzo € Price €	Conf. Unit/Box
231 0071	1/4"		25/100
231 0072	3/8"		25/100
231 0155	1/2"		25/100
231 0156	3/4"		10/40
231 0157	1"		10/40
231 0158	1"1/4		4/16
231 0159	1"1/2		3/12
231 0160	2"		2/8

**2320**

Femmina/femmina ISO 228 con
farfalla rossa
*Female/female ISO 228 with red
T handle*

Codice Code	Tipo Size	Prezzo € Price €	Conf. Unit/Box
231 0053	ISO 7 1/4"		25/100
231 0020	ISO 7 3/8"		25/100
231 0010	1/2"		25/100
231 0012	3/4"		20/80
231 0016	1"		10/40

**2320N**

Femmina/femmina ISO 228 con farfalla nera
Female/female ISO 228 with black T handle

Codice Code	Tipo Size	Prezzo € Price €	Conf. Unit/Box
231 0087	ISO 7 1/4"		25/100
231 0088	ISO 7 3/8"		25/100
231 0161	1/2"		25/100
231 0162	3/4"		20/80
231 0163	1"		10/40

**2321**

Maschio/femmina ISO 228 con farfalla rossa
Male/female ISO 228 with red T handle

Codice Code	Tipo Size	Prezzo € Price €	Conf. Unit/Box
231 0052	1/4"		25/100
231 0022	3/8"		25/100
231 0003	1/2"		25/100
231 0006	3/4"		20/80
231 0007	1"		10/40

**2321N**

Maschio/femmina ISO 228 con farfalla nera
Male/female ISO 228 with black T handle

Codice Code	Tipo Size	Prezzo € Price €	Conf. Unit/Box
231 0164	1/4"		25/100
231 0100	3/8"		25/100
231 0165	1/2"		25/100
231 0166	3/4"		20/80
231 0167	1"		10/40

**2330**

Femmina/femmina ISO 228 con leva acciaio piatta plastificata rossa
Female/female ISO 228 with red steel flat handle

Codice Code	Tipo Size	Prezzo € Price €	Conf. Unit/Box
231 0051	ISO7 1/4"		25/100
231 0049	ISO7 3/8"		25/100
231 0026	1/2"		25/100
231 0019	3/4"		15/60
231 0017	1"		10/40
231 0029	1"1/4		4/16
231 0031	1"1/2		3/12
231 0024	2"		2/8
231 0047	2" 1/2		1/4
231 0040	3"		1/3
231 0050	4"		1/1

**2331**

Maschio/femmina ISO 228 con leva acciaio piatta plastificata rossa
Male/female ISO 228 with red steel flat handle

Codice Code	Tipo Size	Prezzo € Price €	Conf. Unit/Box
231 0056	1/4"		25/100
231 0055	3/8"		25/100
231 0032	1/2"		25/100
231 0033	3/4"		15/60
231 0028	1"		10/40
231 0038	1"1/4		4/16
231 0043	1"1/2		3/12
231 0044	2"		2/8

**2332**

Maschio/maschio ISO 228 con leva acciaio piatta plastificata rossa
Male/male ISO 228 with red steel flat handle

Codice Code	Tipo Size	Prezzo € Price €	Conf. Unit/Box
231 0058	3/8"		25/100
231 0042	1"1/2		3/12
231 0048	2"		2/8

DIMENSIONI
DIMENSIONS

TABELLA DIMENSIONI / DIMENSION TABLE

Dimensione Size	1/4"	3/8"	1/2"	3/4"	1"	1"1/4	1"1/2	2"	2"1/2	3"	4"
Ø (DN)	10	10	15	20	25	32	40	50	60	74	94
A	85	85	85	85	100	140	140	140	240	240	240
A 2320	50	50	50	50	65	-	-	-	-	-	-
A 2330	85	85	85	85	113	141	141	141	240	240	240
B	46	46	51,5	54,5	61,5	73	79	91,5	118	128	142
ØC	23	23	30	37	45	55	68	84	103	124	152
E	10	12	13,5	14,5	14	15	16	17,5	21,5	23,5	27
L	42	47	53	60,5	65	77,5	89	103	130	149	178
Em	11	11,5	10	12	13	14	15	16,5	-	-	-
Lm/f	43	57	56,5	64	70	85,5	96,5	114	-	-	-
Lm/m	-	56	53,5	59,5	69	84	96,5	114	-	-	-
PN	50	50	50	40	40	30	30	25	18	16	16

Tutte le dimensioni (ad eccezione del PN) sono espresse in mm / All dimensions (except for PN) are in mm

NEW

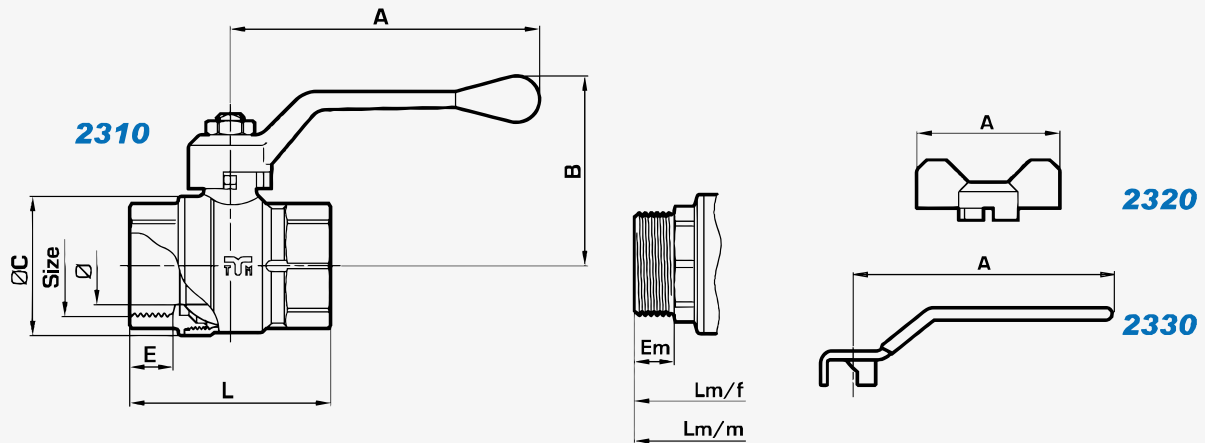
**2450N**

Femmina/femmina ISO228 con premistoppa regolabile e leva alluminio nera
Female/female ISO228 with adjustable packing gland and black aluminium handle

Codice Code	Tipo Size	Prezzo € Price €	Conf. Unit/Box
245 0007	1/2"		20/80
245 0008	3/4"		15/60
245 0009	1"		8/32
245 0023	1"1/4		4/16
245 0024	1"1/2		3/12
245 0025	2"		2/8
231 0152	2" 1/2		1/4
231 0153	3"		1/3
231 0154	4"		1/1

NEW

**2451N**

Maschio/femmina ISO228 con premistoppa regolabile e leva alluminio nera
Male/female ISO228 with adjustable packing gland and black aluminium handle

Codice Code	Tipo Size	Prezzo € Price €	Conf. Unit/Box
245 0013	1/2"		20/80
245 0014	3/4"		15/60
245 0015	1"		8/32
245 0027	1"1/4		4/16
245 0028	1"1/2		3/12
245 0029	2"		2/8

NEW

**2460N**

Femmina/femmina ISO228 con premistoppa regolabile e leva farfalla nera
Female/female ISO228 with adjustable packing gland and black T handle

Codice Code	Tipo Size	Prezzo € Price €	Conf. Unit/Box
245 0010	1/2"		25/100
245 0011	3/4"		15/60
245 0012	1"		10/40
245 0026	1"1/4		5/20

NEW

**2461N**

Maschio/femmina ISO228 con premistoppa regolabile e leva farfalla nera
Male/female ISO228 with adjustable packing gland and black T handle

Codice Code	Tipo Size	Prezzo € Price €	Conf. Unit/Box
245 0016	1/2"		25/100
245 0017	3/4"		15/60
245 0018	1"		10/40
245 0030	1"1/4		5/20

NEW

**2471N**

Maschio/femmina ISO228 con premistoppa regolabile, leva alluminio nera e bocchettone
Male/female ISO228 with adjustable packing gland, male tail piece and black aluminium handle

Codice Code	Tipo Size	Prezzo € Price €	Conf. Unit/Box
245 0001	1/2"		15/60
245 0002	3/4"		10/40
245 0003	1"		6/24
245 0019	1"1/4		4/16
245 0020	1" 1/2		1/4
245 0021	2"		1/2

NEW

**2472N**

Maschio/femmina ISO228 con premistoppa regolabile, leva farfalla nera e bocchettone
Male/female ISO228 with adjustable packing gland male tail piece and black T handle

Codice Code	Tipo Size	Prezzo € Price €	Conf. Unit/Box
245 0004	1/2"		15/60
245 0005	3/4"		10/40
245 0006	1"		7/28
245 0022	1"1/4		5/20

DIMENSIONI
DIMENSIONS

TABELLA DIMENSIONI / DIMENSION TABLE

Dimensione Size	1/2"	3/4"	1"	1"1/4	1"1/2	2"	2"1/2	3"	4"
Ø (DN)	15	20	25	32	40	50	60	74	94
A	85	85	100	100	160	160	240	240	240
A2460	50	50	65	65	-	-	-	-	-
B	52	55,2	62,5	68	88,5	99	118	128	142
Ø C	30	37	45	57	68	84	103	124	152
E	12	13	15	16,5	16	17,5	21,5	23,5	27
E1	12,5	14	16	15	18	18	21,5	23,5	27
L	50	57,5	68	81,5	89	103,5	130	149	178
L1	79,5	89,5	104	122	133,5	164,5	130	149	178
Em	11,5	13,5	14,5	17	15	16,5	-	-	-
Lm/f	56,75	64	76	90	96,5	114,5	-	-	-
PN	64	50	50	50	40	40	18	16	16

Tutte le dimensioni (ad eccezione del PN) sono espresse in mm / All dimensions (except for PN) are in mm

**2360R07**

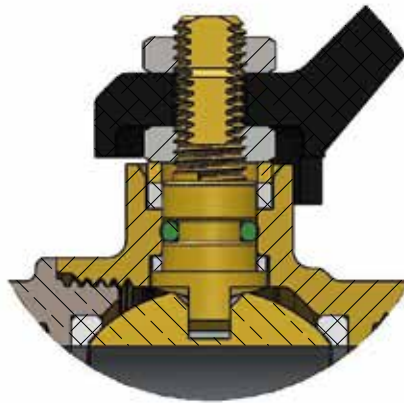
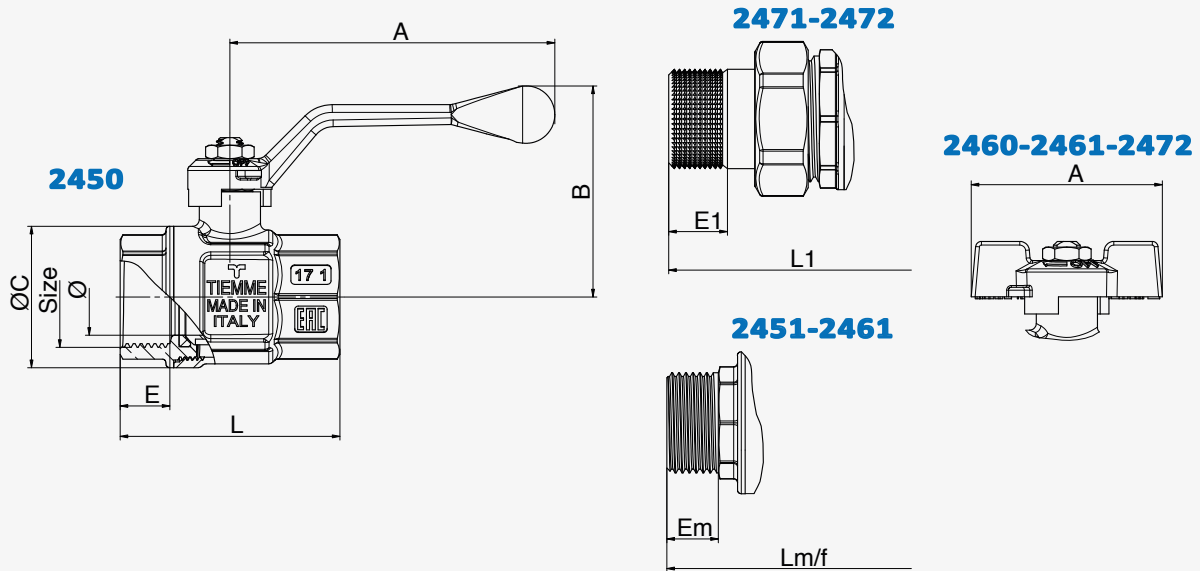
Femmina/femmina ISO 7/EN 10226 con leva alluminio rossa
Female/female ISO 7 / EN 10226 with red aluminium handle

Codice Code	Tipo Size	Prezzo € Price €	Conf. Unit/Box
238 0010	1/2"		20/80
238 0008	3/4"		10/40
238 0002	1"		8/32
238 0013	1"1/4		4/16
238 0014	1"1/2		3/12
238 0003	2"		2/8

**2361N07**

Maschio/femmina ISO 7/EN 10226 con leva alluminio nera
Male/female ISO 7 / EN 10226 with black aluminium handle

Codice Code	Tipo Size	Prezzo € Price €	Conf. Unit/Box
238 0037	1/2"		20/80
238 0047	3/4"		10/40
238 0038	1"		8/32
238 0048	1"1/4		4/16
238 0049	1"1/2		3/12
238 0050	2"		2/8

**2360N07**

Femmina/femmina ISO 7/EN 10226 con leva alluminio nera
Female/female ISO 7 / EN 10226 with black aluminium handle

Codice Code	Tipo Size	Prezzo € Price €	Conf. Unit/Box
238 0043	1/2"		20/80
238 0034	3/4"		10/40
238 0051	1"		8/32
238 0044	1"1/4		4/16
238 0035	1"1/2		3/12
238 0036	2"		2/8

**2370R07**

Femmina/femmina ISO 7/EN 10226 con leva farfalla rossa
Female/female ISO 7 / EN 10226 with red T handle

Codice Code	Tipo Size	Prezzo € Price €	Conf. Unit/Box
238 0015	1/2"		25/100
238 0017	3/4"		15/60
238 0024	1"		8/32
238 0028	1"1/4		5/20

**2361R07**

Maschio/femmina ISO 7/EN 10226 con leva alluminio rossa
Male/female ISO 7 / EN 10226 with red aluminium handle

Codice Code	Tipo Size	Prezzo € Price €	Conf. Unit/Box
238 0016	1/2"		20/80
238 0012	3/4"		10/40
238 0011	1"		8/32
238 0019	1"1/4		4/16
238 0022	1"1/2		3/12
238 0021	2"		2/8

**2370N07**

Femmina/femmina ISO 7/EN 10226 con leva farfalla nera
Female/female ISO 7 / EN 10226 with black T handle

Codice Code	Tipo Size	Prezzo € Price €	Conf. Unit/Box
238 0039	1/2"		25/100
238 0045	3/4"		15/60
238 0040	1"		8/32
238 0052	1"1/4		5/20

**2371R07**

Maschio/femmina ISO 7/EN 10226 con leva farfalla rossa
Male/female ISO 7 / EN 10226 with red T handle

Codice Code	Tipo Size	Prezzo € Price €	Conf. Unit/Box
238 0001	1/2"		25/100
238 0004	3/4"		15/60
238 0009	1"		8/32
238 0025	1"1/4		5/20

**2371N07**

Maschio/femmina ISO 7/EN
10226 con leva farfalla nera
*Male/female ISO 7 / EN 10226
with black T handle*

Codice Code	Tipo Size	Prezzo € Price €	Conf. Unit/Box
238 0041	1/2"		25/100
238 0042	3/4"		15/60
238 0046	1"		8/32
238 0053	1"1/4		5/20

**2381R07**

Maschio/femmina ISO 7/EN
10226 con leva acciaio piatta
plastificata rossa
*Male/female ISO 7/EN 10226
with red steel flat handle*

Codice Code	Tipo Size	Prezzo € Price €	Conf. Unit/Box
238 0026	1/2"		20/80
238 0029	3/4"		10/40
238 0027	1"		8/32
238 0030	1"1/4		4/16
238 0031	1"1/2		3/12
238 0032	2"		2/8

**2380R07**

Femmina/femmina ISO 7/EN
10226 con leva acciaio piatta
plastificata rossa
*Female/female ISO 7/EN 10226
with red steel flat handle*

Codice Code	Tipo Size	Prezzo € Price €	Conf. Unit/Box
238 0006	1/2"		20/80
238 0007	3/4"		10/40
238 0005	1"		8/32
238 0018	1"1/4		4/16
238 0023	1"1/2		3/12
238 0020	2"		2/8

DIMENSIONI
DIMENSIONS

TABELLA DIMENSIONI / DIMENSION TABLE

Dimensione Size	Mod.	1/2"	3/4"	1"	1" 1/4	1" 1/2	2"
Ø (DN)	tutti/all	14,0	18,0	23,5	30,0	37,5	47,0
A	2360/2361	85,0	85,0	100,0	100,0	140,0	140,0
	2370/2371	50,0	50,0	65,0	65,0	-	-
	2380/2381	85,0	85,0	113,0	113,0	141,0	141,0
B	tutti/all	48,0	52,5	59,5	64,5	76,0	89,0
Ø C	tutti/all	27,5	33,5	42,0	53,0	64,0	79,0
E	ISO 7	17,0	18,0	21,5	24,0	24,0	28,5
Em	ISO 7	16,5	18,0	21,0	23,5	23,5	28,0
L	ISO 7	58,0	66,5	78,0	93,0	101,0	121,0
Lm/f	ISO 7	63,5	72,0	83,0	99,1	108,0	129,0
PN		30	30	30	25	25	25

Tutte le dimensioni (ad eccezione del PN) sono espresse in mm / All dimensions (except for PN) are in mm

**2210R**

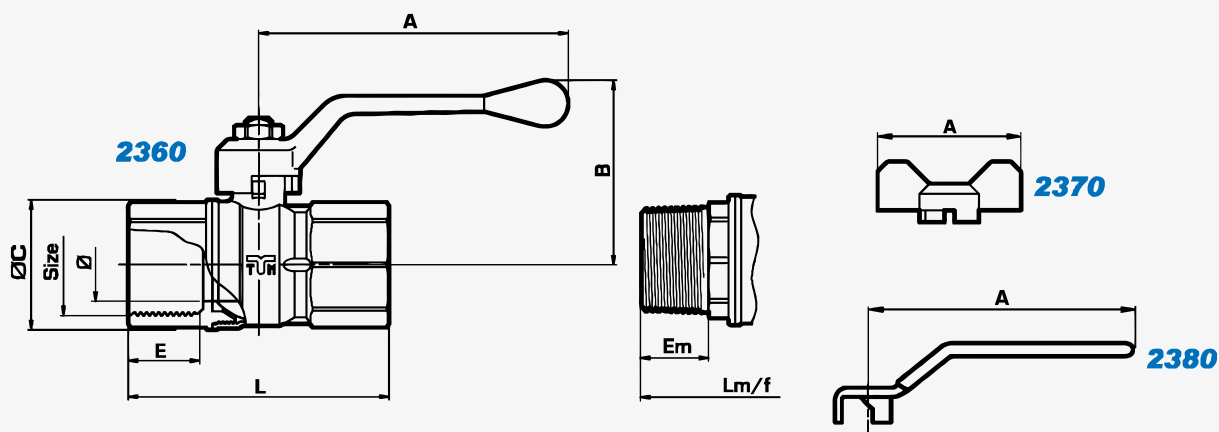
Femmina/femmina ISO 7/EN
10226 con leva alluminio rossa
*Female/female ISO 7/EN 10226
with red aluminium handle*

Codice Code	Tipo Size	Prezzo € Price €	Conf. Unit/Box
231 0045	1/4"		25/100
231 0034	3/8"		25/100
220 0012	1/2"		15/60
220 0015	3/4"		10/40
220 0007	1"		8/32
220 0019	1"1/4		4/16
220 0014	1"1/2		3/12
220 0009	2"		2/8
220 0073	2"1/2		1/4
220 0074	3"		1/3
220 0077	4"		1/1

**2210N**

Femmina/femmina ISO 7/EN
10226 con leva alluminio nera
*Female/female ISO 7/EN 10226
with black aluminium handle*

Codice Code	Tipo Size	Prezzo € Price €	Conf. Unit/Box
220 0027	1/2"		20/80
220 0038	3/4"		10/40
220 0017	1"		8/32
220 0032	1"1/4		4/16
220 0018	1"1/2		3/12
220 0010	2"		2/8
220 0079	2"1/2		1/4
220 0081	3"		1/3
220 0082	4"		1/1

**2211R**

Maschio/femmina ISO 7/EN
10226 con leva alluminio rossa
*Male/female ISO 7/EN 10226
with red aluminium handle*

Codice Code	Tipo Size	Prezzo € Price €	Conf. Unit/Box
220 0013	1/2"		20/80
220 0016	3/4"		10/40
220 0008	1"		8/32
220 0039	1"1/4		4/16
220 0037	1"1/2		3/12
220 0030	2"		2/8

**2211N**

Maschio/femmina ISO 7/EN
10226 con leva alluminio nera
*Male/female ISO 7/EN 10226
with black aluminium handle*

Codice Code	Tipo Size	Prezzo € Price €	Conf. Unit/Box
220 0041	1/2"		20/80
220 0051	3/4"		10/40
220 0043	1"		8/32
220 0055	1"1/4		4/16
220 0050	1"1/2		3/12
220 0044	2"		2/8

**2220R**

Femmina/femmina ISO 7/EN
10226 con farfalla rossa
*Female/female ISO 7/EN 10226
with red T handle*

Codice Code	Tipo Size	Prezzo € Price €	Conf. Unit/Box
231 0053	1/4"		25/100
231 0020	3/8"		25/100
220 0004	1/2"		20/80
220 0006	3/4"		15/60
220 0023	1"		8/32

**2220N**

Femmina/femmina ISO 7/EN
10226 con farfalla nera
*Female/female ISO 7/EN 10226
with black T handle*

Codice Code	Tipo Size	Prezzo € Price €	Conf. Unit/Box
220 0036	1/2"		25/100
220 0048	3/4"		15/60
220 0063	1"		8/32

**2221R**

Maschio/femmina ISO 7/EN
10226 con farfalla rossa
*Male/female ISO 7/EN 10226
with red T handle*

Codice Code	Tipo Size	Prezzo € Price €	Conf. Unit/Box
220 0001	1/2"		20/80
220 0005	3/4"		15/60
220 0011	1"		8/32

**2221N**

Maschio/femmina ISO 7/EN 10226 con farfalla nera
Male/female ISO 7/EN 10226 with black T handle

Codice Code	Tipo Size	Prezzo € Price €	Conf. Unit/Box
220 0028	1/2"		25/100
220 0033	3/4"		15/60
220 0059	1"		8/32

**2231**

Maschio/femmina ISO 7/EN 10226 con leva acciaio piatta plastificata rossa
Male/female ISO 7/EN 10226 with red steel flat handle

Codice Code	Tipo Size	Prezzo € Price €	Conf. Unit/Box
220 0064	1/2"		20/80
220 0068	3/4"		10/40
220 0053	1"		8/32
220 0062	1"1/4		4/16
220 0066	1"1/2		3/12
220 0054	2"		2/8

**2230**

Femmina/femmina ISO 7/EN 10226 con leva acciaio piatta plastificata rossa
Female/female ISO 7/EN 10226 with red steel flat handle

Codice Code	Tipo Size	Prezzo € Price €	Conf. Unit/Box
231 0051	1/4"		25/100
231 0049	3/8"		25/100
220 0026	1/2"		15/60
220 0034	3/4"		10/40
220 0022	1"		8/32
220 0031	1"1/4		4/16
220 0035	1"1/2		3/12
220 0025	2"		2/8
220 0002	2"1/2		1/4
220 0003	3"		1/3
220 0029	4"		1/1

**2240P**

Femmina/femmina ISO 7/EN 10226 piombabile
Female/female ISO 7/EN 10226 sealable ball valve

Codice Code	Tipo Size	Prezzo € Price €	Conf. Unit/Box
220 0061	1/2"		25/100
220 0021	3/4"		15/60
220 0020	1"		8/32
220 0070	1"1/4		4/16
220 0057	1"1/2		3/12
220 0065	2"		2/8

**2230X**

Femmina/femmina ISO 7/EN 10226 con leva acciaio inossidabile piatta plastificata rossa
Female/female ISO 7/EN 10226 with red stainless steel flat handle

Codice Code	Tipo Size	Prezzo € Price €	Conf. Unit/Box
220 0148	1/2"		15/60
220 0149	3/4"		10/40
220 0150	1"		8/32
220 0151	1"1/4		4/16
220 0152	1"1/2		3/12
220 0153	2"		2/8
220 0154	2"1/2		1/4
220 0155	3"		1/3
220 0156	4"		1/1

**2241P**

Maschio/femmina ISO 7/EN 10226 piombabile
Male/female ISO 7/EN 10226 sealable ball valve

Codice Code	Tipo Size	Prezzo € Price €	Conf. Unit/Box
220 0058	1/2"		25/100
220 0072	3/4"		15/60
220 0071	1"		8/32
220 0078	1"1/4		4/16
220 0076	1"1/2		3/12
220 0080	2"		2/8

**2270**

Femmina/femmina ISO 7/EN 10226 con quadro di manovra 28 mm
Female/female ISO 7/EN 10226 with 28 mm square head

Codice Code	Tipo Size	Prezzo € Price €	Conf. Unit/Box
220 0166	3/4"		10/40
220 0167	1"		8/32
220 0168	1"1/4		4/16
220 0169	1"1/2		3/12
220 0170	2"		2/8

**2271**

Maschio/femmina ISO 7/EN 10226 con con quadro di manovra 28 mm
Male/female ISO 7/EN 10226 with 28 mm square head

Codice Code	Tipo Size	Prezzo € Price €	Conf. Unit/Box
220 0177	3/4"		10/40
220 0178	1"		8/32
220 0179	1"1/4		4/16
220 0180	1"1/2		3/12
220 0181	2"		2/8

Valvola a sfera per acqua omologate DVGW W570
General purpose ball valves certified DVGW W570

**2230V**

Femmina/femmina ISO 7/EN 10226 con leva acciaio piatta plastificata verde
Female/female ISO 7/EN 10226 with green steel flat handle

Codice Code	Tipo Size	Prezzo € Price €	Conf. Unit/Box
220 0125	1/4"		25/100
220 0126	3/8"		25/100
220 0127	1/2"		15/60
220 0128	3/4"		10/40
220 0129	1"		8/32
220 0130	1"1/4		4/16
220 0131	1"1/2		3/12
220 0132	2"		2/8

**2231V**

Maschio/femmina ISO 7/EN 10226 con leva acciaio piatta plastificata verde
Male/female ISO 7/EN 10226 with green steel flat handle

Codice Code	Tipo Size	Prezzo € Price €	Conf. Unit/Box
220 0136	1/2"		20/80
220 0137	3/4"		10/40
220 0138	1"		8/32
220 0139	1"1/4		4/16
220 0140	1"1/2		3/12
220 0141	2"		2/8

DIMENSIONI
DIMENSIONS

TABELLA DIMENSIONI / DIMENSION TABLE

Dimensione Size	1/4"	3/8"	1/2"	3/4"	1"	1"1/4	1"1/2	2"	2"1/2	3"	4"
Ø (DN)	10	10	15	20	25	32	40	50	65	80	100
A 2210	85	85	85	100	100	140	140	160	-	-	-
A 2220	50	50	50	65	65	-	-	-	-	-	-
A 2230	85	85	85	113	113	141	141	141	240	240	240
A 2240	-	-	22	27	27	32	32	32	-	-	-
A 2270	-	-	-	36	36	36	36	36	-	-	-
B	39	39	44,5	53,5	57,5	73,5	79,5	92	125,5	136	150,5
B 2270	-	-	-	63,15	67,15	78,5	84,2	97	-	-	-
ØC	23	23	32,5	39	48	59	71	86	114	131	164
E	10	12	16,5	18	20,6	23,5	23,5	28	34	37	43
L	42	47	59,5	67,5	79	96	105	126	156	177	214
Em	-	-	16,5	18	21	23,5	23,5	28	-	-	-
Lm	-	-	67,5	75,5	87	106	114	136,5	-	-	-
PN	50	50	50	40	40	30	30	25	20	20	20

Tutte le dimensioni (ad eccezione del PN) sono espresse in mm / All dimensions (except for PN) are in mm

NEW

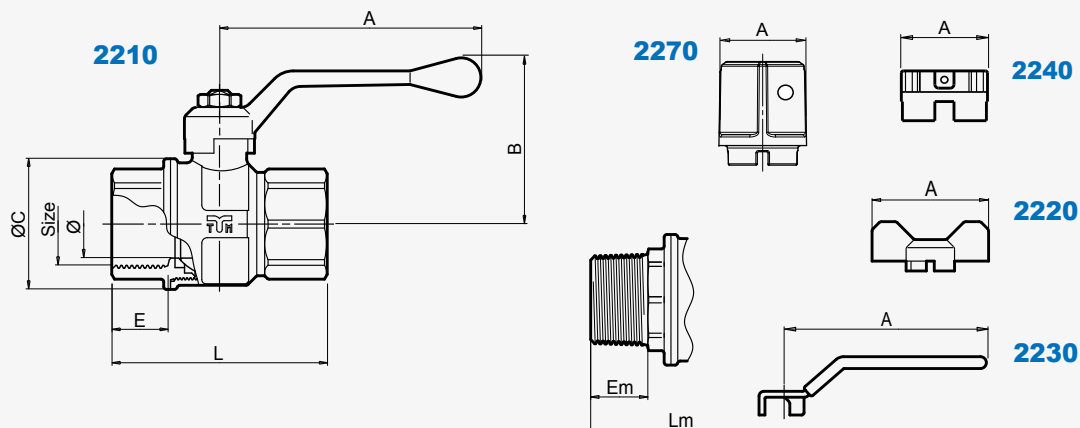
**2232**

Valvole URAGANO per coibentazione femmina/femmina ISO7/EN 10226 con leva piatta rossa
Ball valve URAGANO for thermic insulation female/female ISO7/EN 10226 with red plastic coated flat handle

Codice Code	Tipo Size	Prezzo € Price €	Conf. Unit/Box
220 0192	1/2"		12/48
220 0193	3/4"		8/32
220 0194	1"		6/24
220 0195	1"1/4		3/12
220 0196	1"1/2		2/8
220 0197	2"		2/8

NEW

**2233**

Valvole URAGANO per coibentazione maschio/femmina ISO7/EN 10226 con leva piatta rossa
Ball valve URAGANO for thermic insulation male/female ISO7/EN 10226 with red plastic coated flat handle

Codice Code	Tipo Size	Prezzo € Price €	Conf. Unit/Box
220 0198	1/2"		12/48
220 0199	3/4"		8/32
220 0200	1"		6/24
220 0201	1"1/4		3/12
220 0202	1"1/2		2/8
220 0203	2"		2/8

DIMENSIONI
DIMENSIONS

TABELLA DIMENSIONI / DIMENSION TABLE

Dimensione Size	1/2"	3/4"	1"	1"1/4	1"1/2	2"
Ø (DN)	15	20	25	32	40	50
A	85	85	114	140	140	140
B	88,5	90,5	105,5	131	137	157
ØC	32,5	38,7	48	59	71	86
D	47,8	46,7	47	63	63	75
E	16,5	18	20,6	23,5	23,5	28
L	59,5	67,5	79	95,3	104,5	126
Em	16,5	18	21	23,5	23,5	28
Lm	67,5	75,5	86,6	105,3	113,5	136,5
PN	50	40	40	30	30	25

Tutte le dimensioni (ad eccezione del PN) sono espresse in mm / All dimensions (except for PN) are in mm

**2610**

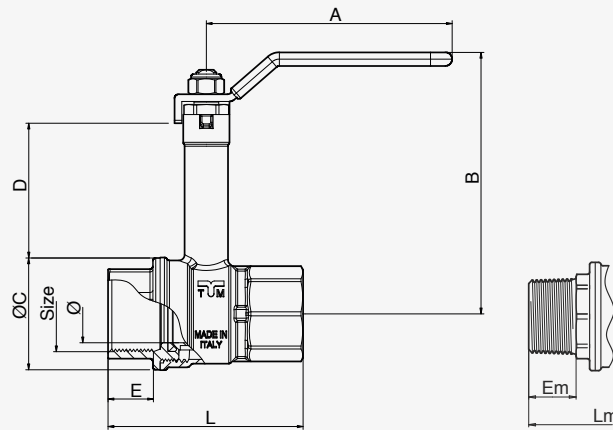
Femmina/femmina ISO 7/EN 10226 con leva alluminio nera
Female/female ISO 7/EN 10226 with black aluminium handle

Codice Code	Tipo Size	Prezzo € Price €	Conf. Unit/Box
261 0004	3/4"		10/40
261 0005	1"1/2		2/8
261 0001	2"		2/8

Fino ad esaurimento scorta / until out of stock



TABELLA DIMENSIONI / DIMENSION TABLE

Dimensione Size	3/4"	1"1/2	2"
Ø (DN)	20	40	50
A 2610	100	140	160
B	58,5	85	101
Ø C	40	71	85,5
E	21	29,5	33,5
L	80	120	140
PN	40	30	25

Tutte le dimensioni (ad eccezione del PN) sono espresse in mm / All dimensions (except for PN) are in mm

**2121**

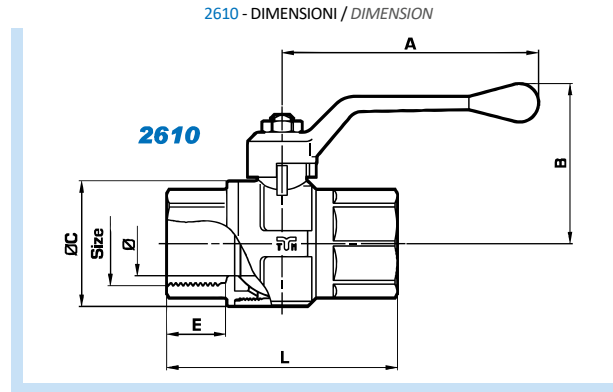
Maschio/femmina ISO 228 con leva farfalla rossa per collettori e O-RING
Male/female ball valve ISO 228 with red T handle and O-RING for manifold connection

Codice Code	Tipo Size	Prezzo € Price €	Conf. Unit/Box
212 0003	1/2"		20/80
212 0001	3/4"		10/40
212 0002	1"		7/28
212 0004	1"1/4		6/24

Disponibile anche con leva blu / also available with blu handle

**2121CP**

Maschio/femmina ISO 228 con leva farfalla rossa per collettori e GUARNIZIONE PIANA
Male/female ball valve ISO 228 with red T handle and FLAT WASHER for manifold connection

Codice Code	Tipo Size	Prezzo € Price €	Conf. Unit/Box
212 0025	1/2"		20/80
212 0021	3/4"		10/40
212 0015	1"		9/36
212 0024	1"1/4		6/24
212 0122	1"1/2		3/12

Con leva alluminio / with aluminium handle

Disponibile anche con leva blu / also available with blu handle

**2180**

Maschio/femmina a squadra ISO 228 con leva farfalla rossa per collettori e O-RING
Male/female angle valve ISO 228 with red T handle and O-RING for manifold connection

Codice Code	Tipo Size	Prezzo € Price €	Conf. Unit/Box
212 0008	1/2"		15/60
212 0005	3/4"		10/40
212 0006	1"		5/20

Disponibile anche con leva blu / also available with blu handle

**2180CP**

Maschio/femmina a squadra ISO 228 con leva farfalla rossa per collettori e GUARNIZIONE PIANA
Male/female angle valve ISO 228 with red T handle and FLAT WASHER for manifold connection

Codice Code	Tipo Size	Prezzo € Price €	Conf. Unit/Box
212 0035	1/2"		15/60
212 0034	3/4"		10/40
212 0016	1"		5/20

Disponibile anche con leva blu / also available with blu handle

**2121R**

Valvola diritta con pretenuta
Straight valve with O-RING

Codice Code	Tipo Size	Prezzo € Price €	Conf. Unit/Box
con farfalla blu / with blue T handle			

212 0156	1/2"		20/80
212 0020	3/4"		10/40
212 0014	1"		9/36
212 0028	1"1/4		6/24

con farfalla rossa / with red T handle

212 0155	1/2"		20/80
212 0017	3/4"		10/40
212 0013	1"		9/36
212 0027	1"1/4		6/24

nuovo prodotto / new product

**2180CPR**

Valvola a squadra con pretenuta e GUARNIZIONE PIANA
Angle valve and FLAT WASHER

Codice Code	Tipo Size	Prezzo € Price €	Conf. Unit/Box
con farfalla blu / with blue T handle			

212 0054	3/4"		10/40
212 0045	1"		5/20

con farfalla rossa / with red T handle

212 0056	3/4"		10/40
212 0057	1"		5/20

"CP": TENUTA CON GUARNIZIONE PIANA
WITH FLAT WASHER

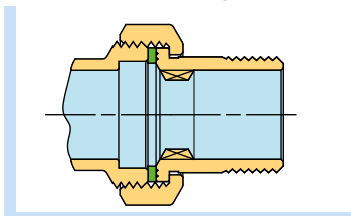

TENUTA CON O-RING
WITH O-RING

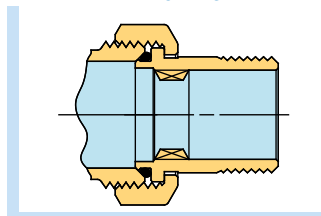

"CPR": PRETENUTA CON GUARNIZIONE PIANA
WITH FLAT WASHER

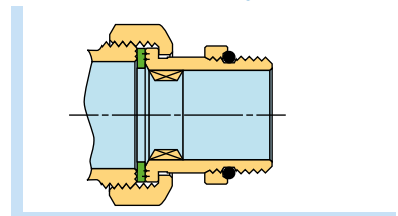

**2182**

Valvola a squadra ISO 228 con tenuta con O-RING
Angle valve ISO 228 and O-RING

Codice Code	Tipo Size	Prezzo € Price €	Conf. Unit/Box
con farfalla blu / with blue T handle			
212 0047	1/2"		15/60
212 0039	3/4"		10/40
212 0041	1"		5/20
con farfalla rossa / with red T handle			
212 0046	1/2"		15/60
212 0038	3/4"		10/40
212 0040	1"		5/20

**2182R**

Valvola a squadra ISO 228 con pretenuta e tenuta con O-RING
Angle valve ISO 228 with O-RING

Codice Code	Tipo Size	Prezzo € Price €	Conf. Unit/Box
con farfalla blu / with blue T handle			
212 0049	3/4"		10/40
212 0044	1"		5/20
con farfalla rossa / with red T handle			
212 0050	3/4"		10/40
212 0048	1"		5/20

**2120R**

Valvola diritta con attacco termometro reversibile
Straight valve with thermometer reversible connection

Codice Code	Tipo Size	Prezzo € Price €	Conf. Unit/Box
con farfalla blu / with blue T handle			
212 0042	1"		5/20
con farfalla rossa / with red T handle			
212 0043	1"		5/20

2120R - Attacco termometro reversibile / thermometer with reversible connection

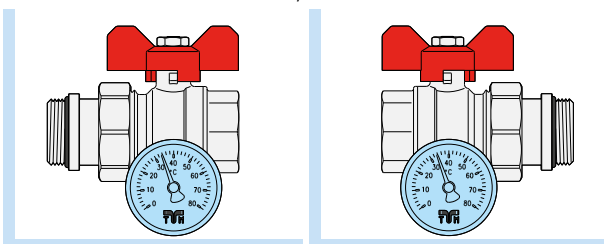
**2183R**

Valvola a squadra ISO 228 con pretenuta, tenuta con O-RING e termometro con attacco reversibile
Angle valve ISO 228 with O-RING and thermometer with reversible connection

Codice Code	Tipo Size	Prezzo € Price €	Conf. Unit/Box
con farfalla blu / with blue T handle			
212 0032	1"		5/20
con farfalla rossa / with red T handle			
212 0031	1"		5/20

2183R - Attacco termometro reversibile / thermometer with reversible connection

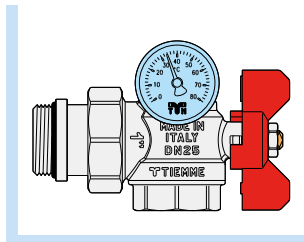
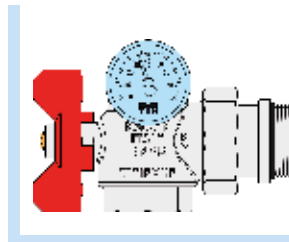
**2227**

Maschio/femmina ISO 7/EN 10226 con leva farfalla rossa per collettori
Male/female ISO 7/EN 10226 with red T handle for manifold

Codice Code	Tipo Size	Prezzo € Price €	Conf. Unit/Box
212 0010	1/2"		15/60
212 0007	3/4"		10/40
212 0009	1"		6/24

Disponibile anche con leva blu / also available with blu handle

TENUTA CON O-RING
WITH O-RING

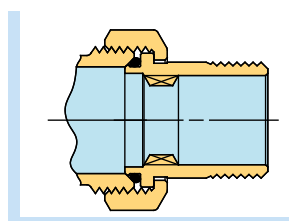

"CPR": PRETENUTA E TENUTA CON O-RING
WITH O-RING

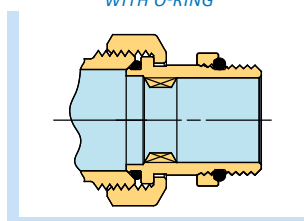

Per tubo multistrato
For multilayer pipe**2143**

Tubo multistrato/tubo multistrato con leva alluminio rossa
Ball valve with multilayer pipe connections and red aluminium handle

Codice Code	Tipo Size	Prezzo € Price €	Conf. Unit/Box
162 0022	16 x 2,0		20/80
162 0011	18 x 2,0		15/60
162 0005	20 x 2,0		15/60

Disponibile con leva acciaio piatta plastificata rossa (2163) / Red flat steel handle available (2163)

**2153**

Tubo multistrato/tubo multistrato con leva farfalla rossa
Ball valve with multilayer pipe connections and red T handle

Codice Code	Tipo Size	Prezzo € Price €	Conf. Unit/Box
162 0020	16 x 2,0		20/80
162 0006	18 x 2,0		15/60
162 0003	20 x 2,0		15/60

Disponibile con leva farfalla blu (cod. 162 0021) / Blu T handle available (code 162 0021)

**2153FLR**

Valvole a sfera con flangia attacchi per tubo multistrato e leva a farfalla rossa
Ball valve with compression ends and red T handle

Codice Code	Tipo Size	Prezzo € Price €	Conf. Unit/Box
162 0029	16 x 2,0		20/80
162 0031	20 x 2,0		15/60

**2153FLB**

Valvole a sfera con flangia attacchi per tubo multistrato e leva a farfalla blu
Ball valve with compression ends and blue T handle

Codice Code	Tipo Size	Prezzo € Price €	Conf. Unit/Box
162 0030	16 x 2,0		20/80
162 0032	20 x 2,0		15/60

**2154R**

Valvole a sfera maschio con attacco per tubo multistrato e leva a farfalla rossa
Ball valve male with compression end and red T handle

Codice Code	Tipo Size	Prezzo € Price €	Conf. Unit/Box
162 0025	16 x 2,0 - 1/2"		20/80
162 0037	20 x 2,0 - 3/4"		15/60

**2154B**

Valvole a sfera maschio con attacco per tubo multistrato e leva a farfalla blu
Ball valve male with compression end and blue T handle

Codice Code	Tipo Size	Prezzo € Price €	Conf. Unit/Box
162 0026	16 x 2,0 - 1/2"		20/80
162 0038	20 x 2,0 - 3/4"		15/60

**2154FLR**

Valvole a sfera maschio con flangia attacco per tubo multistrato e leva a farfalla rossa
Ball valve male with compression end and red T handle

Codice Code	Tipo Size	Prezzo € Price €	Conf. Unit/Box
162 0035	16 x 2,0 - 1/2"		20/80
162 0041	20 x 2,0 - 3/4"		15/60

**2154FLB**

Valvole a sfera maschio con flangia attacco per tubo multistrato e leva a farfalla blu
Ball valve male with compression end and blue T handle

Codice Code	Tipo Size	Prezzo € Price €	Conf. Unit/Box
162 0036	16 x 2,0 - 1/2"		20/80
162 0042	20 x 2,0 - 3/4"		15/60

**2155R**

Valvole a sfera femmina con flangia attacco per tubo multistrato e leva a farfalla rossa
Ball valve female with compression end and red T handle

Codice Code	Tipo Size	Prezzo € Price €	Conf. Unit/Box
162 0027	16 x 2,0 - 1/2"		20/80
162 0039	20 x 2,0 - 3/4"		15/60

Per tubo multistrato
For multilayer pipe**2155B**

Valvole a sfera femmina con attacco per tubo multistrato e leva a farfalla blu
Ball valve female with compression end and blue T handle

Codice Code	Tipo Size	Prezzo € Price €	Conf. Unit/Box
162 0028	16 x 2,0 - 1/2"		20/80
162 0040	20 x 2,0 - 3/4"		15/60

**2155FLR**

Valvole a sfera femmina con flangia attacco per tubo multistrato e leva a farfalla rossa
Ball valve female with compression end and red T handle

Codice Code	Tipo Size	Prezzo € Price €	Conf. Unit/Box
162 0033	16 x 2,0 - 1/2"		20/80
162 0043	20 x 2,0 - 3/4"		15/60

**2155FLB**

Valvole a sfera femmina con flangia attacco per tubo multistrato e leva a farfalla blu
Ball valve female with compression end and blue T handle

Codice Code	Tipo Size	Prezzo € Price €	Conf. Unit/Box
162 0034	16 x 2,0 - 1/2"		20/80
162 0044	20 x 2,0 - 3/4"		15/60

**2156R**

Valvole a sfera maschio con attacco per tubo multistrato e leva a farfalla rossa
Ball valve male with compression end and red T handle

Codice Code	Tipo Size	Prezzo € Price €	Conf. Unit/Box
162 0051	20 x 2,0 - 3/4"		15/60

**2156B**

Valvole a squadra maschio con attacco per tubo multistrato e leva a farfalla blu
Ball valve male with compression end and blue T handle

Codice Code	Tipo Size	Prezzo € Price €	Conf. Unit/Box
162 0052	20 x 2,0 - 3/4"		15/60

**2157R**

Valvola a sfera con leva a farfalla rossa, con estremità a stringere per tubo multistrato e dado folle
Ball valve with red T handle with compression multilayer pipe end loose nut

Codice Code	Tipo Size	Prezzo € Price €	Conf. Unit/Box
162 0047	20 x 2,0 - 3/4"		10/40
162 0060	20 x 2,0 - 1"		10/40
162 0049	26 x 3,0 - 3/4"		10/40
162 0062	26 x 3,0 - 1"		10/40

nuovo prodotto / new product

**2157B**

Valvola a sfera con leva a farfalla blu, con estremità a stringere per tubo multistrato e dado folle
Ball valve with blue T handle with compression multilayer pipe end loose nut

Codice Code	Tipo Size	Prezzo € Price €	Conf. Unit/Box
162 0048	20 x 2,0 - 3/4"		10/40
162 0061	20 x 2,0 - 1"		10/40
162 0050	26 x 3,0 - 3/4"		10/40
162 0063	26 x 3,0 - 1"		10/40

nuovo prodotto / new product

**2181CPR**

Valvola a squadra con pretenuta e GUARNIZIONE PIANA
Angle valve with FLAT WASHER

Codice Code	Tipo Size	Prezzo € Price €	Conf. Unit/Box
con farfalla blu / with blue T handle			
162 0046	20 x 3/4"		10/40
162 0004	26 x 3/4"		10/40
162 0009	26 x 1"		5/20
162 0013	32 x 1"		5/20
con farfalla rossa / with red T handle			
162 0045	20 x 3/4"		10/40
162 0014	26 x 3/4"		10/40
162 0010	26 x 1"		5/20
162 0015	32 x 1"		5/20

Per tubo multistrato
For multilayer pipe**1697**Valvola a sfera dritta con leva farfalla rossa e girello folle
Straight ball valve with red "T" handle and loose nut

Codice Code	Tipo Size	Prezzo € Price €	Conf. Unit/Box
168 0021	20 x 3/4"		20/80
168 0035	25 x 3/4"		20/80
168 0030	26 x 3/4"		20/80
168 0032	32 x 1"		10/40

**1697CK**Valvola a sfera dritta con leva farfalla rossa, girello folle e valvola di non ritorno
Straight ball valve with red "T" handle, loose nut and check valve

Direzione flusso / Flow direction

Codice Code	Tipo Size	Prezzo € Price €	Conf. Unit/Box
168 0029	20 x 3/4"		20/80
168 0027	25 x 3/4"		20/80
168 0036	26 x 3/4"		20/80
168 0037	32 x 1"		10/40

**1692**Valvola a sfera a squadra con leva farfalla rossa e girello folle
Angle ball valve with red "T" handle and loose nut

Codice Code	Tipo Size	Prezzo € Price €	Conf. Unit/Box
168 0019	20 x 3/4"		10/40
168 0028	25 x 3/4"		10/40
168 0020	26 x 3/4"		10/40
168 0034	32 x 1"		10/40

**1692CK**Valvola a sfera a squadra con leva farfalla rossa, girello folle e valvola di non ritorno
Angle ball valve with red "T" handle, loose nut and check valve

Direzione flusso / Flow direction

Codice Code	Tipo Size	Prezzo € Price €	Conf. Unit/Box
168 0026	20 x 3/4"		10/40
168 0018	25 x 3/4"		10/40
168 0031	26 x 3/4"		10/40
168 0022	32 x 1"		10/40

**1690**Valvola a sfera da incasso
Built in ball valve

Codice Code	Tipo Size	Prezzo € Price €	Conf. Unit/Box
168 0002	16 x 16		5/50
168 0004	18 x 18		5/50
168 0001	20 x 20		5/50
168 0009	25 x 25		5/50
168 0003	26 x 26		5/50

**1690U**Valvola a sfera da incasso con geometria a "U"
Built in ball valve "U" shape

Codice Code	Tipo Size	Prezzo € Price €	Conf. Unit/Box
168 0013	16 x 16		1/25
168 0011	20 x 20		1/25
168 0016	25 x 25		1/25
168 0033	26 x 26		1/25



Per tubo multistrato
For multilayer pipe

1691
Valvola a sfera con leva farfalla
Ball valve with T handle

Codice Code	Tipo Size	Prezzo € Price €	Conf. Unit/Box
168 0010	16 x 16		5/50
168 0065	18 x 18		5/50
168 0007	20 x 20		5/50
168 0025	25 x 25		5/50
168 0008	26 x 26		5/50



1696
Valvola con vitone da incasso
2 vie
Built in 2 ways valve with screw

Codice Code	Tipo Size	Prezzo € Price €	Conf. Unit/Box
168 0012	16 x 16		5/50
168 0017	18 x 18		5/50
168 0014	20 x 20		5/50
168 0024	25 x 25		5/50
168 0023	26 x 26		5/50

Per tubo rame
For copper pipe

2142
Tubo rame/tubo rame con leva
alluminio rossa
Ball valve with copper pipe
connections and red aluminium
handle

Codice Code	Tipo Size	Prezzo € Price €	Conf. Unit/Box
214 0004	15		15/60
214 0008	18		15/60
214 0002	22		10/40
214 0005	28		7/28



2152
Tubo rame/tubo rame con leva
farfalla rossa
Ball valve with copper pipe
connections and red T handle

Codice Code	Tipo Size	Prezzo € Price €	Conf. Unit/Box
214 0003	15		15/60
214 0006	18		15/60
214 0001	22		10/40
214 0007	28		7/28

**2263**

Valvola diritta femmina ISO 228
con girello
*Female straight valve ISO 228
with loose nut/water meter
connection*

Codice Code	Tipo Size	Prezzo € Price €	Conf. Unit/Box
226 0002	1/2" x 1/2"		10/60
226 0001	3/4" x 3/4"		10/60
226 0003	1" x 1"		10/40
226 0044	1/2" x 3/4"		20/80
226 0020	1/2" x 3/4"		20/80
226 0021	3/4" x 1"		10/40

Versione nichelata / *nickel-plated version*

**2263CK**

Valvola diritta femmina ISO 228
con girello e non ritorno
*Female straight valve ISO 228
with check valve and loose nut/
water meter connection*

Codice Code	Tipo Size	Prezzo € Price €	Conf. Unit/Box
226 0004	1/2" x 1/2"		20/80
226 0005	3/4" x 3/4"		20/80
226 0006	1" x 1"		10/40
226 0022	1/2" x 3/4"		20/80
226 0023	3/4" x 1"		10/40

Versione nichelata / *nickel-plated version*

**2266**

Valvola diritta maschio ISO 228
con girello
*Male straight valve ISO 228
with loose nut/water meter
connection*

Codice Code	Tipo Size	Prezzo € Price €	Conf. Unit/Box
226 0050	1/2" M ISO7 x 1/2" F		20/80
226 0049	1/2" M ISO7 x 3/4" F		20/80
226 0010	3/4" M - 3/4" F		20/80
226 0012	3/4" M - 1" F		10/40

**2266CK**

Valvola diritta maschio ISO 228
con girello e non ritorno
*Male straight valve ISO 228
with check valve and loose nut/
water meter connection*

➤ Direzione flusso / *Flow direction*

Codice Code	Tipo Size	Prezzo € Price €	Conf. Unit/Box
226 0011	3/4" M - 3/4" F		20/80
226 0013	3/4" M - 1" F		10/40

**2266N**

Valvole a sfera maschio ISO228
con dado folle e leva farfalla
nera
*Female Ball valves male end
ISO228 with loose nut and black
T handle*

Codice Code	Tipo Size	Prezzo € Price €	Conf. Unit/Box
226 0048	1/2" M ISO7 - 1/2" F		20/80
226 0047	1/2" M ISO7 - 3/4" F		20/80
226 0046	3/4" M - 3/4" F		20/80

**2980**

DRAIN valvola a sfera con spurgo
DRAIN ball valve with drain

Codice Code	Tipo Size	Prezzo € Price €	Conf. Unit/Box
298 0002	1/2"		15/60
298 0003	3/4"		10/40
298 0005	1"		8/32
298 0009	1"1/4		4/16
298 0004	1"1/2		3/12
298 0007	2"		2/8

**2985**

Valvola a sfera a passaggio totale
con attacco M 10x1 per sonda
temperatura
*Full bore valve with probe
connection M 10x1*

Codice Code	Tipo Size	Prezzo € Price €	Conf. Unit/Box
298 0006	1/2"		25/100
298 0001	3/4"		15/60
298 0008	1"		10/40

**22660T**

Valvola a sfera estremità
maschio ISO 228 e dado folle
con leva ottone
*Male straight valve ISO 228
with loose nut/water meter
connection*

Codice Code	Tipo Size	Prezzo € Price €	Conf. Unit/Box
226 0028	3/4" M con battuta piana x 3/4" F <i>3/4" M with plain ends x 3/4" F</i>		15/60

Resistenti alla dezincificazione
Dezincification resistant

GR

**2030CZ**

Valvola a sfera femmina/
femmina ISO 228 con leva piatta
plastificata rossa
*Ball valve female/female ISO
228 with red flat handle*

Codice Code	Tipo Size	Prezzo € Price €	Conf. Unit/Box
203 0011	3/8"		25/100
203 0002	1/2"		20/80
203 0003	3/4"		10/40
203 0001	1"		10/40
203 0005	1"1/4		4/16
203 0009	1"1/2		3/12
203 0008	2"		2/8

**2132CZ**

Valvola a sfera tubo rame/tubo
rame con leva piatta plastificata
rossa
*Ball valve compression ends with
red flat handle*

Codice Code	Tipo Size	Prezzo € Price €	Conf. Unit/Box
203 0010	12		25/100
203 0006	15		15/60
203 0012	18		10/40
203 0004	22		10/40
203 0007	28		7/28

Resistenti alla dezincificazione
Dezincification resistant**3675CZLOCK**

Femmina/femmina ISO 7/EN 10226 con filtro e leva piatta acciaio lucchettabile plastificata rossa

Female/female ISO 7/EN 10226 with filter and red teel flat lockable handle

Codice Code	Tipo Size	Prezzo € Price €	Conf. Unit/Box
203 0022	1/2"		7/28
203 0023	3/4"		6/24
203 0024	1"		4/16

RUBINETTI A SFERA "EOLO"
"EOLO" BALL BIBCOCKS**2510**Rubinetto con leva alluminio rossa e portagomma
Bibcock with red aluminium handle and hose connection

Codice Code	Tipo Size	Prezzo € Price €	Conf. Unit/Box
250 0012	3/8"		12/48
250 0001	1/2"		12/48
250 0003	3/4"		7/28
250 0004	1"		4/16

**2510N**Rubinetto con leva alluminio nera e portagomma
Bibcock with black aluminium handle and hose connection

Codice Code	Tipo Size	Prezzo € Price €	Conf. Unit/Box
250 0042	3/8"		12/48
250 0043	1/2"		12/48
250 0044	3/4"		7/28
250 0045	1"		4/16

**2560**Rubinetto con leva alluminio rossa
Bibcock with red aluminium handle

Codice Code	Tipo Size	Prezzo € Price €	Conf. Unit/Box
250 0019	1/2"		12/48

**2520**Rubinetto con farfalla rossa e portagomma
Bibcock with red T handle and hose connection

Codice Code	Tipo Size	Prezzo € Price €	Conf. Unit/Box
250 0007	1/2"		12/48

**2520B**Rubinetto con farfalla blu e portagomma
Bibcock with blue T handle and hose connection

Codice Code	Tipo Size	Prezzo € Price €	Conf. Unit/Box
250 0053	1/2"		12/48



2570
Rubinetto con leva farfalla rossa
Bibcock with red T handle

Codice Code	Tipo Size	Prezzo € Price €	Conf. Unit/Box
250 0013	1/2"		12/48



2570B
Rubinetto con leva farfalla blu
Bibcock with blue T handle

Codice Code	Tipo Size	Prezzo € Price €	Conf. Unit/Box
250 0051	1/2"		12/48



2530
Rubinetto con leva acciaio piatta
plastificata rossa e portagomma
*Bibcock with red plasticized
steel flat handle and hose connection*

Codice Code	Tipo Size	Prezzo € Price €	Conf. Unit/Box
250 0006	1/2"		12/48
250 0008	3/4"		7/28
250 0015	1"		4/16



2530X
Rubinetto con leva acciaio
inossidabile piatta plastificata
rossa e portagomma
*Bibcock with red plasticized
stainless steel flat handle and
hose connection*

Codice Code	Tipo Size	Prezzo € Price €	Conf. Unit/Box
250 0052	1/2"		12/48
250 0046	3/4"		7/28
250 0047	1"		4/16



2584
Rubinetto lucchettabile
Lockable bibcock

Codice Code	Tipo Size	Prezzo € Price €	Conf. Unit/Box
250 0009	1/2"		12/48



2590
Rubinetto lucchettabile
Lockable bibcock

Codice Code	Tipo Size	Prezzo € Price €	Conf. Unit/Box
250 0017	1/2"		12/48



2530X316
Rubinetto a sfera con
portagomma con **leva acciaio
inossidabile AISI 316 grigia piatta
plastificata**
*Bibcock EOLO with hose-end
with grey plastic coated AISI 316
stainless steel flat handle*

AISI 316

Codice Code	Tipo Size	Prezzo € Price €	Conf. Unit/Box
250 0061	1/2"		10/40



2531V
Rubinetto a sfera **EOLO NO
FROST** con doppio portagomma
e leva in acciaio piatta verde
*NO FROST Bibcock EOLO with
two hose-end and green plastic
coated steel flat handle*

NO FROST

Codice Code	Tipo Size	Prezzo € Price €	Conf. Unit/Box
250 0058	1/2"		10/40
250 0059	3/4"		7/28



2511B
Rubinetto a sfera **EOLO NO
FROST** con portagomma e leva
alluminio blu
*NO FROST Bibcock EOLO with
hose-end and blue aluminium
handle*

NO FROST

Codice Code	Tipo Size	Prezzo € Price €	Conf. Unit/Box
250 0075	1/2"		25/50
250 0076	3/4"		20/40



2535V
Rubinetto a sfera **EOLO
DUPLEX NO FROST** con doppio
portagomma e leva piatta verde
*NO FROST Bibcock EOLO DUPLEX
with two hose-end and green
plastic coated flat handle*

NO FROST

Codice Code	Tipo Size	Prezzo € Price €	Conf. Unit/Box
250 0062	1/2"		5/20

**2585G**

Rubinetto con portagomma
serie pesante
*Bibcock heavy model with hose
connection*

Codice Code	Tipo Size	Prezzo € Price €	Conf. Unit/Box
258 0001	1/2"		10/40
258 0003	3/4"		8/32
258 0007	1"		4/16

**2586G**

Rubinetto curvo serie pesante
Bibcock heavy model

Codice Code	Tipo Size	Prezzo € Price €	Conf. Unit/Box
258 0005	1/2"		10/40
258 0010	3/4"		10/40
258 0013	1"		5/20

**2585C**

Rubinetto serie pesante sabbato
e cromato con portagomma
*Bibcock heavy model
sandblasted and chrome-plated
with hose connection*

Codice Code	Tipo Size	Prezzo € Price €	Conf. Unit/Box
258 0002	1/2"		10/40
258 0008	3/4"		8/32
258 0004	1"		4/16

Versione cromata lucida / *chrome finish version*

**2586C**

Rubinetto curvo serie pesante
sabbato e cromato
*Bibcock heavy model
sandblasted and chrome-plated*

Codice Code	Tipo Size	Prezzo € Price €	Conf. Unit/Box
258 0006	1/2"		10/40
258 0012	3/4"		5/20
258 0014	1"		5/20

Fino a esaurimento scorta / *until out of stock*

**2588C**

Rubinetto curvo cromato - serie
pesante
*Bibcock chrome plated heavy
model*

Codice Code	Tipo Size	Prezzo € Price €	Conf. Unit/Box
258 0043	1/2"		10/40

Resistenti alla dezincificazione
 Dezincification resistant
**2900NCZ**
 Valvola SMALL femmina/
 femmina con levetta nera
 SMALL valve female/female with
 black short handle

Codice Code	Tipo Size	Prezzo € Price €	Conf. Unit/Box
290 0052	3/8"		15/225
290 0036	1/2"		10/150

**2901NCZ**
 Valvola SMALL maschio/
 femmina con levetta nera
 SMALL valve male/female with
 black short handle

Codice Code	Tipo Size	Prezzo € Price €	Conf. Unit/Box
290 0014	3/8"		15/225
290 0003	1/2"		10/150

**2902NCZ**
 Valvola SMALL maschio/maschio
 con levetta nera
 SMALL valve male/male with
 black short handle

Codice Code	Tipo Size	Prezzo € Price €	Conf. Unit/Box
290 0040	3/8"		15/225
290 0024	1/2"		10/150

**2902CZ**
 Valvola SMALL maschio/maschio
 con levetta cromata
 SMALL valve male/male with
 chrome-plated short handle

Codice Code	Tipo Size	Prezzo € Price €	Conf. Unit/Box
290 0048	3/8"		15/225

▽ Fino ad esaurimento scorta / until out of stock

**2940NCZ**
 Valvola SMALL tubo rame/
 femmina con levetta nera
 SMALL valve copper/female with
 black short handle

Codice Code	Tipo Size	Prezzo € Price €	Conf. Unit/Box
290 0035	10 x 1/2"		10/150
290 0025	12 x 1/2"		10/150
290 0026	15 x 1/2"		9/135

**2942NCZ**
 Valvola SMALL tubo rame/tubo
 rame con levetta nera
 SMALL valve copper/copper with
 black short handle

Codice Code	Tipo Size	Prezzo € Price €	Conf. Unit/Box
290 0015	10 x 10		10/150
290 0023	10 x 12		10/150
290 0018	10 x 15		9/135
290 0010	12 x 12		10/150
290 0029	12 x 15		9/135
290 0002	15 x 15		7/105

**2910CZ**
 Valvola curva maschio/femmina
 con levetta cromata
 mini valves male/female with
 chrome - plated short handle

Codice Code	Tipo Size	Prezzo € Price €	Conf. Unit/Box
290 0046	1/2"		6/90

**2911CZ**
 Valvola curva tubo rame/tubo
 rame con levetta cromata
 mini valves copper/copper
 compression ends with chrome -
 plated short handle

Codice Code	Tipo Size	Prezzo € Price €	Conf. Unit/Box
290 0055	12 x 12		5/75
290 0013	15 x 15		4/60

Resistenti alla dezincificazione
 Dezincification resistant

GR

**2912CZ**
 Mini valvola 3 vie con sfera a T tubo rame/tubo rame con levetta cromata
 Three ways mini valves with T shape ball with copper/copper compression ends with chrome-plated short handle

Codice Code	Tipo Size	Prezzo € Price €	Conf. Unit/Box
290 0058	12 x 12 x 12		4/60
290 0020	15 x 15 x 15		4/60

**2942CZSL**
 Valvola SMALL tubo rame/tubo rame senza levetta
 SMALL valve copper pipe connection without handle with screwdriver slot

Codice Code	Tipo Size	Prezzo € Price €	Conf. Unit/Box
290 0028	10 x 10		10/150
290 0049	10 x 15		9/135

Fino ad esaurimento scorta / until out of stock

**2940CZ**
 Valvola SMALL tubo rame/femmina con levetta cromata
 SMALL valve copper/female with chrome-plated short handle

Codice Code	Tipo Size	Prezzo € Price €	Conf. Unit/Box
290 0044	15 x 1/2"		9/135

Fino ad esaurimento scorta / until out of stock

**2940CZSL**
 Valvola SMALL tubo rame/femmina senza levetta
 SMALL valve copper/female without handle with screwdriver slot

Codice Code	Tipo Size	Prezzo € Price €	Conf. Unit/Box
290 0039	12 x 1/2"		10/150

Fino ad esaurimento scorta / until out of stock

**2900**

Femmina/femmina con levetta nera
Female/female with black short handle

Codice Code	Tipo Size	Prezzo € Price €	Conf. Unit/Box
290 0022	1/4"		30/180
290 0016	3/8"		25/150
290 0006	1/2"		20/120

**2901**

Maschio/femmina con levetta nera
Male/female with black short handle

Codice Code	Tipo Size	Prezzo € Price €	Conf. Unit/Box
290 0011	1/4"		30/180
290 0004	3/8"		25/150
290 0001	1/2"		20/120

**2902**

Maschio/maschio con levetta nera
Male/male with black short handle

Codice Code	Tipo Size	Prezzo € Price €	Conf. Unit/Box
290 0045	1/4"		30/180
290 0031	3/8"		25/150
290 0008	1/2"		20/120

**2940**

Tubo rame/femmina con levetta nera
Compression end/female with black short handle

Codice Code	Tipo Size	Prezzo € Price €	Conf. Unit/Box
290 0033	10 x 1/2"		20/120
290 0034	12 x 1/2"		20/120
290 0030	15 x 1/2"		15/90
290 0041	16 x 1/2"		15/90

**2942**

Tubo rame/tubo rame con levetta nera
Compression ends with black short handle

Codice Code	Tipo Size	Prezzo € Price €	Conf. Unit/Box
290 0012	10 x 10		20/120
290 0005	12 x 12		20/120
290 0059	14 x 14		20/120
290 0007	15 x 15		15/90
290 0060	16 x 16		15/90

**2931**

Maschio/femmina con taglio cacciavite
Male/female with screwdriver slot

Codice Code	Tipo Size	Prezzo € Price €	Conf. Unit/Box
290 0019	3/8"		25/150

**2932**

Maschio/maschio con taglio cacciavite
Male/male with screwdriver slot

Codice Code	Tipo Size	Prezzo € Price €	Conf. Unit/Box
290 0056	3/8"		40/240
290 0054	1/2"		25/150

**2944**

Mini valvola a sfera per tubo multistrato levetta alluminio rossa e blu
Mini ball valve for multilayer pipe with red and blue aluminium short handle

Codice Code	Tipo Size	Prezzo € Price €	Conf. Unit/Box
con levetta blu / with blue short handle			
294 0028	16 sp 2,0 - 1/2"		25/100
294 0043	18 sp 2,0 - 1/2"		25/100
con levetta rossa / with red short handle			
294 0029	16 sp 2,0 - 1/2"		25/100
294 0044	18 sp 2,0 - 1/2"		25/100

**2944K**

Mini valvola a sfera cromata per tubo multistrato levetta alluminio rossa e blu
Chrome-plated mini ball valve for multilayer pipe with red and blue aluminium short handle

Codice Code	Tipo Size	Prezzo € Price €	Conf. Unit/Box
con levetta blu / with blue short handle			
294 0027	16 sp 2,0 - 1/2"		1/50
294 0036	18 sp 2,0 - 1/2"		1/50
con levetta rossa / with red short handle			
294 0026	16 sp 2,0 - 1/2"		1/50
294 0033	18 sp 2,0 - 1/2"		1/50

**2945**

Mini valvola a sfera per tubo rame levetta alluminio rossa e blu
Mini ball valve for copper pipe with red and blue aluminium short handle

Codice Code	Tipo Size	Prezzo € Price €	Conf. Unit/Box
con levetta blu / with blue short handle			
294 0019	15 - 1/2"		25/100
294 0016	16 - 1/2"		25/100
294 0034	18 - 1/2"		25/100
con levetta rossa / with red short handle			
294 0020	15 - 1/2"		25/100
294 0018	16 - 1/2"		25/100
294 0035	18 - 1/2"		25/100

**2945K**

Mini valvola a sfera cromata per tubo rame levetta alluminio rossa e blu
Chrome-plated mini ball valve for copper pipe with red and blue aluminium short handle

Codice Code	Tipo Size	Prezzo € Price €	Conf. Unit/Box
con levetta blu / with blue short handle			
294 0042	15 - 1/2"		1/50
294 0045	16 - 1/2"		1/50
294 0046	18 - 1/2"		1/50
con levetta rossa / with red short handle			
294 0041	15 - 1/2"		1/50
294 0047	16 - 1/2"		1/50
294 0048	18 - 1/2"		1/50

**2947**

Mini valvola a sfera per tubo PEX levetta alluminio rossa e blu
Mini ball valve for PEX pipe with red and blue aluminium short handle

Codice Code	Tipo Size	Prezzo € Price €	Conf. Unit/Box
con levetta blu / with blue short handle			
294 0021	15 sp 2,5 - 1/2"		25/100
294 0001	16 sp 2,0 - 1/2"		25/100
294 0013	16 sp 2,2 - 1/2"		25/100
294 0007	18 sp 2,0 - 1/2"		25/100
294 0011	18 sp 2,5 - 1/2"		25/100
con levetta rossa / with red short handle			
294 0022	15 sp 2,5 - 1/2"		25/100
294 0002	16 sp 2,0 - 1/2"		25/100
294 0014	16 sp 2,2 - 1/2"		25/100
294 0008	18 sp 2,0 - 1/2"		25/100
294 0012	18 sp 2,5 - 1/2"		25/100

**2947K**

Mini valvola a sfera cromata per tubo PEX levetta alluminio rossa e blu

Chrome-plated mini ball valve for PEX pipe with red and blue aluminium short handle

Codice Code	Tipo Size	Prezzo € Price €	Conf. Unit/Box
con levetta blu / with blue short handle			
294 0039	15 sp 2,5 - 1/2"		1/50
294 0015	16 sp 2,0 - 1/2"		1/50
294 0052	16 sp 2,2 - 1/2"		1/50
294 0025	18 sp 2,0 - 1/2"		1/50
294 0037	18 sp 2,5 - 1/2"		1/50
con levetta rossa / with red short handle			
294 0040	15 sp 2,5 - 1/2"		1/50
294 0017	16 sp 2,0 - 1/2"		1/50
294 0053	16 sp 2,2 - 1/2"		1/50
294 0032	18 sp 2,0 - 1/2"		1/50
294 0038	18 sp 2,5 - 1/2"		1/50

**2946**

Mini valvola a sfera maschio/femmina levetta rossa e blu
Mini ball valve male/female with red and blue short handle

Codice Code	Tipo Size	Prezzo € Price €	Conf. Unit/Box
con levetta blu / with blue short handle			
294 0023	1/2" (Ø 16) - 1/2"		25/100
294 0005	1/2" - 1/2"		25/100
294 0003	1/2" - 1/2"		25/100
294 0009	1/2" - 1/2"		25/100
con levetta rossa / with red short handle			
294 0024	1/2" (Ø 16) - 1/2"		25/100
294 0006	1/2" - 1/2"		25/100
294 0004	1/2" - 1/2"		25/100
294 0010	1/2" - 1/2"		25/100

Leva in plastica blu e rossa, corpo nichelato / blue or red plastic handle, nickel-plated body

Leva in alluminio blu e rossa, corpo nichelato / blue or red aluminium handle, nickel-plated body

Leva in alluminio blu e rossa - corpo giallo / blue or red aluminium handle, yellow body

2946 - DETTAGLIO / DETAIL

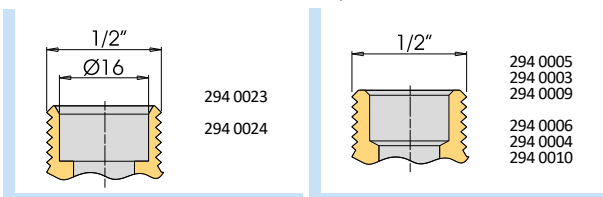
**2957**

Mini valvola a sfera cromata maschio/maschio levetta alluminio rossa e blu
Chrome-plated mini ball valve male/male with red and blue aluminium short handle

Codice Code	Tipo Size	Prezzo € Price €	Conf. Unit/Box
con levetta blu / with blue short handle			
294 0030	1/2" - 24x19 fil (Ø18)		1/50
con levetta rossa / with red short handle			
294 0031	1/2" - 24x19 fil (Ø18)		1/50

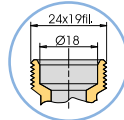
**2941**

Minivalvole a sfera per collettori maschio/girello con levetta in alluminio rossa
Mini ball valves for manifolds male/loose nut with red short aluminium handle

Codice Code	Tipo Size	Prezzo € Price €	Conf. Unit/Box
294 0054	1/2" x 1/2"		25/100

2941 - DETTAGLIO / DETAIL

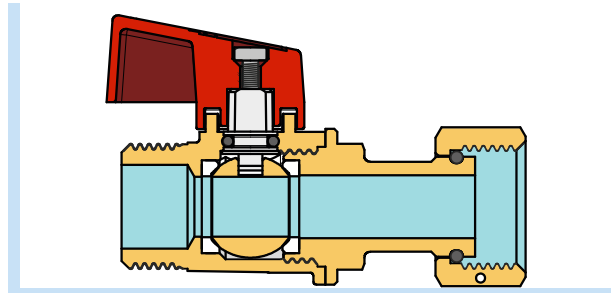

NEW

**2139**

Valvola a sfera motorizzata, passaggio totale, a 2 vie femmina /femmina, per attuatore con basetta ISO5211
2-way motorized ball valve, full port, female/female, for actuators with ISO5211

Codice Code	Tipo Size	Prezzo € Price €	Conf. Unit/Box
213 0104	1/2"		15/60
213 0107	3/4"		10/40
213 0108	1"		7/28

**2138**

Valvola a sfera compresa di servomotore a 2 vie - attacchi maschio/femmina
2-way ball valve with servomotor - male/female connection

Codice Code	Tipo Size	Aliment. Power	Prezzo € Price €	Conf. Unit/Box
213 0020	1/2"	230 Vac		1/14
213 0003	3/4"	230 Vac		1/14
213 0007	1"	230 Vac		1/14
213 0019	1"1/4	230 Vac		1/14

Disponibile anche con alimentazione 24Vac / available also with 24Vac power supply

**2133**

Valvola a sfera compresa di servomotore a 2 vie - attacchi maschio/maschio
2-ways ball valve with servomotor - male/male connection

Codice Code	Tipo Size	Aliment. Power	Prezzo € Price €	Conf. Unit/Box
213 0011	3/4"	230 Vac		1/14
213 0016	1"	230 Vac		1/14

Disponibile anche con alimentazione 24Vac / available also with 24Vac power supply

**9535**

Servomotore per valvole di zona 2 vie (2138 - 2133); rotazione monodirezionale con angolo di 90° fornito con fusibile di protezione. Custodia con grado di protezione IP44
Servomotor for 2-ways valve (2138 - 2133); directional rotation 90° supplied with protection fuse. Case with protection degree IP44

Codice Code	Tensione Voltage	Tempo Control time	Prezzo € Price €	Conf. Unit/Box
213 0024	230 Vac	40 sec		1/8
213 0072	24 Vac	40 sec		1/8

**2134**

Valvola a sfera deviatrice compresa di servomotore a 3 vie - attacchi a 3 bocchettoni
3-ways diverter ball valve with servomotor - 3 unions connections

Codice Code	Tipo Size	Aliment. Power	Prezzo € Price €	Conf. Unit/Box
213 0009	3/4"	230 Vac		1/4
213 0018	1"	230 Vac		1/4

Disponibile anche con alimentazione 24Vac / available also with 24Vac power supply

**9537**

Servomotore per valvola deviatrice (2134); rotazione monodirezionale con angolo di 180° fornito con fusibile di protezione. Custodia con grado di protezione IP44
Servomotor for diverter valve (2134); directional rotation 180° supplied with protection fuse. Case with protection degree IP44

Codice Code	Tensione Voltage	Tempo Control time	Prezzo € Price €	Conf. Unit/Box
213 0025	230 Vac	80 sec		1/8
213 0031	24 Vac	80 sec		1/8

**2136**

Valvola a sfera con servomotore a 3 vie con by-pass - attacchi a 4 bocchettoni, interasse variabile (50-63 mm per valvola 3/4"; 55-63 mm per valvola 1")
3-ways ball valve with servomotor and by-pass - 4 unions connections, variable distance between centers (50-63 mm for 3/4" valves; 55-63 mm for 1" valves)

Codice Code	Tipo Size	Aliment. Power	Prezzo € Price €	Conf. Unit/Box
213 0013	3/4"	230 Vac		1/4
213 0028	1"	230 Vac		1/4

Disponibile anche con alimentazione 24Vac / available also with 24Vac power supply

**2137**

Valvola a sfera compresa di servomotore a 3 vie con by-pass - attacchi a 3 bocchettoni
3-ways ball valve with servomotor and by-pass - 3 unions connections

Codice Code	Tipo Size	Aliment. Power	Prezzo € Price €	Conf. Unit/Box
213 0021	3/4"	230 Vac		1/4
213 0015	1"	230 Vac		1/4

Disponibile anche con alimentazione 24Vac / available also with 24Vac power supply

**9536**

Servomotore per valvole di zona con by-pass (2136-2137); rotazione bidirezionale con angolo di 90° fornito con fusibile di protezione. Custodia con grado di protezione IP44

Servomotor for by-pass valve (2136-2137); bidirectional rotation 90° supplied with protection fuse. Case with protection degree IP44

Codice Code	Tensione Voltage	Tempo Control time	Prezzo € Price €	Conf. Unit/Box
213 0030	230 Vac	40 sec		1/8
213 0037	24 Vac	40 sec		1/8

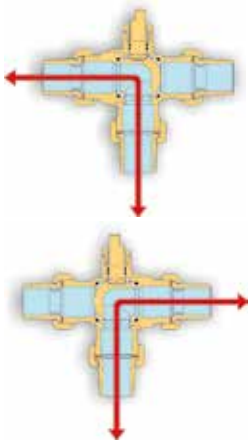

2134
CARATTERISTICHE TECNICHE
 TECHNICAL FEATURES

Alimentazione / Power supply
230 Vac o 24 Vac
 Contatto relé / Relay contact
6A 250 Vac
 Grado di protezione / Protection degree class
IP 44
 Coppia max di rotazione / Max rotation
8 Nm
 Tempo di rotazione / Control time
80 sec.
 Fusibile / Fuse
5x20 F350 mA.

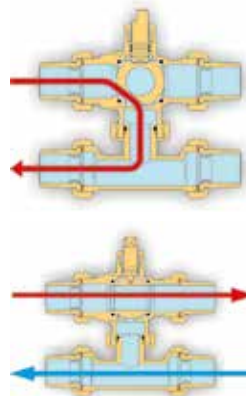
2136
CARATTERISTICHE TECNICHE
 Technical features

Alimentazione / Power supply
230 Vac o 24 Vac
 Contatto relé / Relay contact
6A 250 Vac
 Grado di protezione / Protection degree class
IP 44
 Coppia max di rotazione / Max rotation
8 Nm
 Tempo di rotazione / Control time
40 sec.
 Fusibile / Fuse
5x20 F350 mA.

2137
CARATTERISTICHE TECNICHE
 Technical features

Alimentazione / Power supply
230 Vac o 24 Vac
 Contatto relé / Relay contact
6A 250 Vac
 Grado di protezione / Protection degree class
IP 44
 Coppia max di rotazione / Max rotation
8 Nm
 Tempo di rotazione / Control time
40 sec.
 Fusibile / Fuse
5x20 F350 mA.

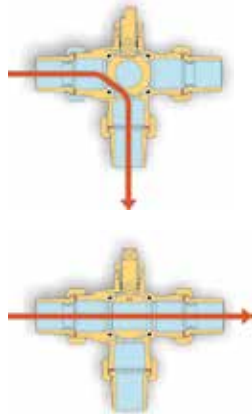
2138
CARATTERISTICHE TECNICHE
 Technical features

Alimentazione / Power supply
230 Vac o 24 Vac
 Contatto relé / Relay contact
6A 250 Vac
 Grado di protezione / Protection degree class
IP 44
 Coppia max di rotazione / Max rotation
8 Nm
 Tempo di rotazione / Control time
40 sec.
 Fusibile / Fuse
5x20 F350 mA.

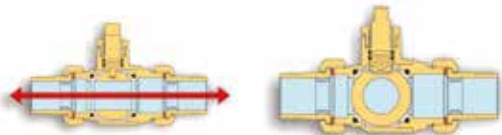
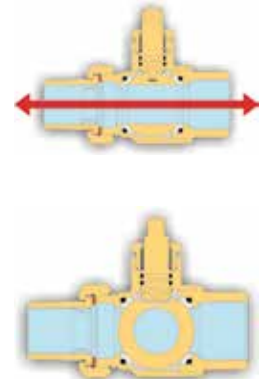
2133
CARATTERISTICHE TECNICHE
 Technical features

Alimentazione / Power supply
230 Vac o 24 Vac
 Contatto relé / Relay contact
6A 250 Vac
 Grado di protezione / Protection degree class
IP 44
 Coppia max di rotazione / Max rotation
8 Nm
 Tempo di rotazione / Control time
40 sec.
 Fusibile / Fuse
5x20 F350 mA.

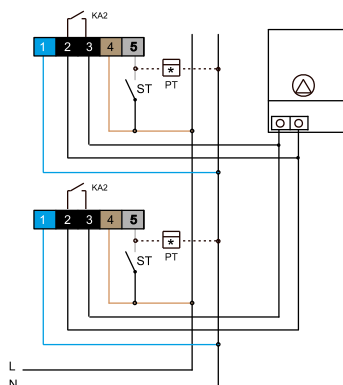
SCHEMA ELETTRICO DEL SERVOMOTORE
 SERVMOTOR'S ELECTRICAL DIAGRAM

- 1 BLU / BLUE - NEUTRO, NEUTRAL
- 2 NERO / BLACK - microinterruttore, microswitch
- 3 NERO / BLACK - microinterruttore, microswitch
- 4 MARRONE / BROWN - FASE, PHASE
- 5 GRIGIO / GREY - TERMOSTATO AMBIENTE, ROOM THERMOSTAT

**2948**

Sottolavabo con filtro snodo e rosone
Under sink valve with rosette, filter and flexible coupling

Codice Code	Tipo Size	Prezzo € Price €	Conf. Unit/Box
295 0007	10 x 1/2"		15/60

**2949**

Sottolavabo con filtro e rosone
Under sink valve with filter and rosette

Codice Code	Tipo Size	Prezzo € Price €	Conf. Unit/Box
295 0054	10 x 1/2"		15/60

**2958**

Sottolavabo compatto con filtro e rosone
Compact under sink valve with filter and rosette

Codice Code	Tipo Size	Prezzo € Price €	Conf. Unit/Box
295 0073	10 x 1/2"		15/60

**2959**

Valvola speciale sottolavabo compatta con filtro e rosone
Compact under sink valve with filter and rosette

Codice Code	Tipo Size	Prezzo € Price €	Conf. Unit/Box
295 0049	1/2" x 3/8"		15/60
295 0055	1/2" x 1/2"		15/60

**2956**

Valvole speciali sottolavabo con filtro e rosone
Special under sink valve with filter and rosette

Codice Code	Tipo Size	Prezzo € Price €	Conf. Unit/Box
295 0004	1/2" x 3/8"		15/60
295 0012	1/2" x 1/2"		15/60

**2966**

Curvetta sottolavabo 90°
Fixed 90° elbow

Codice Code	Tipo Size	Prezzo € Price €	Conf. Unit/Box
295 0066	1/2" x 3/8"		10/40

**2950**

WASH rubinetto lavatrice maschio/maschio ISO 228
levetta cromata
WASH hose-bibcock for washing machine chrome plated short handle

Codice Code	Tipo Size	Prezzo € Price €	Conf. Unit/Box
295 0018	1/2" x 1/2"		25/100
295 0011	1/2" x 3/4"		10/50

**2953**

WASH rubinetto lavatrice maschio/maschio ISO 228 con rosone
WASH hose-bibcock for washing machine with rosette

Codice Code	Tipo Size	Prezzo € Price €	Conf. Unit/Box
295 0010	1/2" x 1/2"		15/60
295 0003	1/2" x 3/4"		10/50

**3908C**

Rubinetto lavatrice (con vitone) cromato, con rosone
Chromed bibcock for washing machine with rosette

Codice Code	Tipo Size	Prezzo € Price €	Conf. Unit/Box
295 0165	1/2" x 3/4"		1/60

**3909C**

Rubinetto a squadra doppio cromato con rosone
Chrome-plated cut-off double, with rosette

Codice Code	Tipo Size	Prezzo € Price €	Conf. Unit/Box
295 0178	1/2" x (1/2"-3/8")		1/10

2954

Valvola squadra maschio/
maschio ISO 228 levetta cromata
Angle valve male/male ISO 228
chromed short handle

Codice Code	Tipo Size	Prezzo € Price €	Conf. Unit/Box
295 0002	1/2" x 1/2"		1/50
295 0019	1/2" x 3/4"		1/50

2954 - DIMENSIONI / DIMENSION

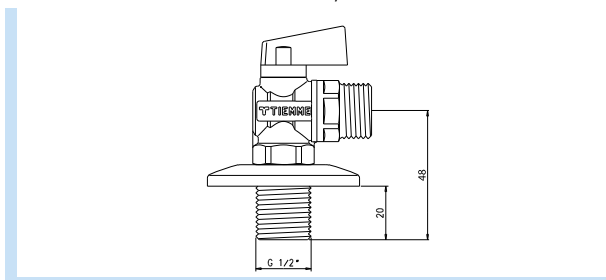
3900C

Rubinetto d'arresto (con vitone)
cromato, con rosone e DADO
LUNGO
Chrome-plated cut-off cock with
rosette and LONG NUT

Codice Code	Tipo Size	Prezzo € Price €	Conf. Unit/Box
295 0016	1/2" x 10		10/50

3901C

Rubinetto d'arresto (con vitone)
cromato, con rosone senza dado
Chrome-plated cut-off cock with
rosette without nut

Codice Code	Tipo Size	Prezzo € Price €	Conf. Unit/Box
295 0013	1/2" x 3/8"		10/50
295 0008	1/2" x 1/2"		10/50

3907C

Rubinetto d'arresto (con vitone)
cromato, con rosone e DADO
STANDARD
Chrome-plated cut-off cock with
rosette and STANDARD NUT

Codice Code	Tipo Size	Prezzo € Price €	Conf. Unit/Box
295 0133	1/2" x 10		1/60

3906C

Rubinetto d'arresto (con vitone)
cromato, con rosone senza dado
Chrome-plated cut-off cock with
rosette without nut

Codice Code	Tipo Size	Prezzo € Price €	Conf. Unit/Box
295 0132	1/2" x 3/8"		1/60
295 0130	1/2" x 1/2"		1/60

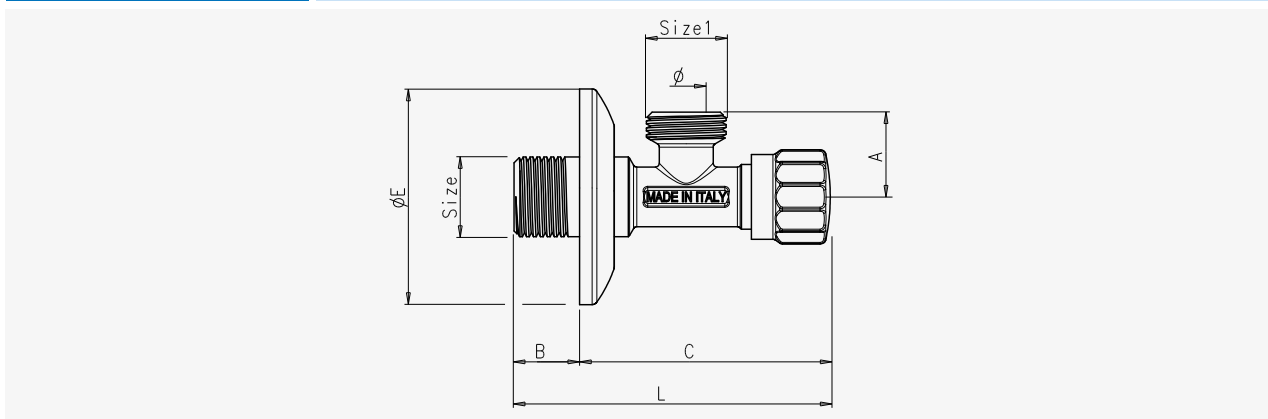
3901C- 3906C
**DIMENSIONI
DIMENSIONS**

TABELLA DIMENSIONI / DIMENSION TABLE

Codice/ Code	Size	Size 1	ø (DN)	A	B	C	ø E	L	PN
295 0013	1/2"	3/8"	10	23	14	76	56	90	10
295 0008	1/2"	1/2"	10	23	14	76	56	90	10
295 0132	1/2"	3/8"	10	22	14	68	56	82	10
295 0130	1/2"	1/2"	10	22	14	68	56	82	10

**3904C**

Rubinetto d'arresto (con sfera) cromato, con rosone senza dado (1/4" di giro)
Chrome-plated cut-off cock (with ball), with rosette without nut (turn 1/4")

Codice Code	Tipo Size	Prezzo € Price €	Conf. Unit/Box
295 0037	1/2 " x 3/8 "		10/50
295 0070	1/2 " x 1/2 "		10/50

**3910**

Raccordo cromato diritto maschio per collegamenti idro-sanitari
Male chrome-plated fitting for hydro-sanitary connections

Codice Code	Tipo Size	Prezzo € Price €	Conf. Unit/Box
295 0059	10 x 3/8"		10/300
295 0033	10 x 1/2"		10/250

**3911**

Raccordo cromato diritto doppio per collegamenti idro-sanitari
Double chrome-plated fitting for hydro-sanitary connections

Codice Code	Tipo Size	Prezzo € Price €	Conf. Unit/Box
295 0039	10 x 10		10/300

**3902C**

Sottolavabo inclinato maschio/ tubo rame con filtro, snodo e rosone
Under sink valve with rosette, filter and flexible coupling

Codice Code	Tipo Size	Prezzo € Price €	Conf. Unit/Box
295 0038	1/2 " x 10		1/50

**3903C**

Sottolavabo inclinato maschio/ tubo rame con filtro e rosone
Under sink valve with filter and rosette

Codice Code	Tipo Size	Prezzo € Price €	Conf. Unit/Box
295 0076	1/2 " x 3/8 "		1/50

**3997**

Sottolavabo con vitone
Under sink valve with head screw

Codice Code	Tipo Size	Prezzo € Price €	Conf. Unit/Box
295 0042	1/2"		20/60

**3905C**

Curva per doccia maschio/ maschio saliscendi
Elbow for shower male/male

Codice Code	Tipo Size	Prezzo € Price €	Conf. Unit/Box
295 0027	1/2"		20/60

**3912**

Raccordo cromato diritto femmina per collegamenti idro-sanitari
Female chrome-plated fitting for hydro-sanitary connections

Codice Code	Tipo Size	Prezzo € Price €	Conf. Unit/Box
295 0062	10 x 3/8"		10/350
295 0050	10 x 1/2"		10/300

**2964**

Valvola ad incasso PN 10 femmina/femmina con rosone regolabile e maniglia
Built-in PN 10 female/female with adjustable rosette and handle

Codice Code	Tipo Size	Prezzo € Price €	Conf. Unit/Box
295 0079	1/2"		5/20
295 0142	3/4"		5/20

**2964Z**

Valvola ad incasso PN 10 femmina/femmina con rosone regolabile e maniglia metallica
Built-in PN 10 female/female with adjustable rosette and metallic handle

Codice Code	Tipo Size	Prezzo € Price €	Conf. Unit/Box
295 0134	1/2"		5/20
295 0135	3/4"		5/20
295 0136	1"		5/20

**2967**

Rubinetto con vitone PN 10 femmina/femmina con martellina
Bibcock with head screw PN 10 female/female

Codice Code	Tipo Size	Prezzo € Price €	Conf. Unit/Box
295 0080	1/2"		20/80
295 0081	3/4"		15/60

**2960**

INWALL valvola a sfera da incasso senza leva
INWALL built-in ball valve without handle

Codice Code	Tipo Size	Prezzo € Price €	Conf. Unit/Box
295 0005	1/2"		15/60
295 0020	3/4"		10/40

**2961**

INWALL valvola a sfera da incasso a saldare
INWALL built-in ball valve with soldering ends

Codice Code	Tipo Size	Prezzo € Price €	Conf. Unit/Box
295 0077	15		10/40
295 0074	18		5/20
295 0078	22		5/20

**2960SET**

Set cappuccio e rosone per valvole ad incasso per 2960, 1690, 1690U, 1696, 1740, 1740U e 1746
Cap and rosette for built-in valve for 2960, 1690, 1690U, 1696, 1740, 1740U and 1746

Codice Code	Tipo Size	Prezzo € Price €	Conf. Unit/Box
295 0006	-		1/25

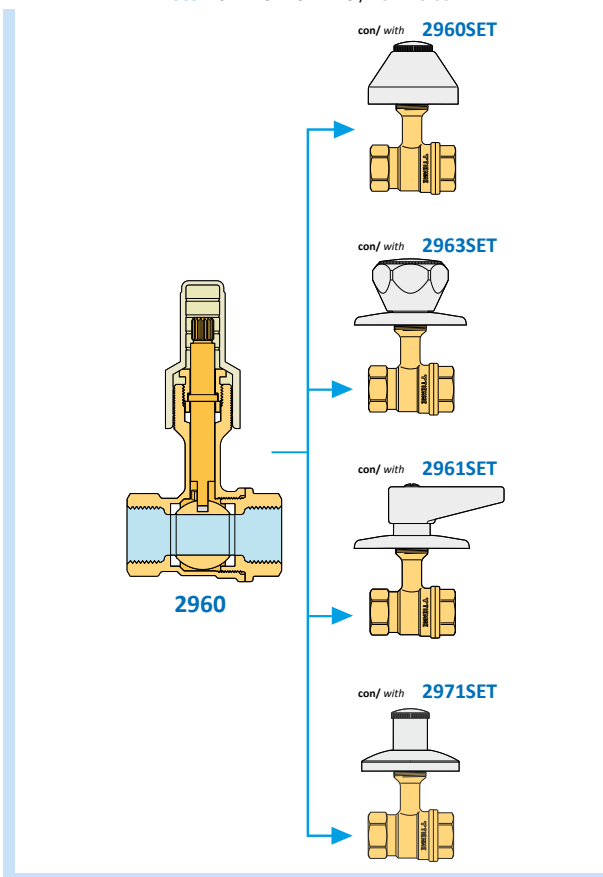
2960 - ESEMPIO DI UTILIZZO / HOW TO USE**2961SET**

Set leva e rosone per valvole ad incasso per 2960, 1690, 1690U, 1696, 1740, 1740U e 1746
Handle and rosette for built-in valve for 2960, 1690, 1690U, 1696, 1740, 1740U and 1746

Codice Code	Tipo Size	Prezzo € Price €	Conf. Unit/Box
295 0009	-		1/25

**2963SET**

Set maniglia e rosone per valvole ad incasso per 2960, 1690, 1690U, 1696, 1740, 1740U e 1746
Handle and rosette for built-in valve for 2960, 1690, 1690U, 1696, 1740, 1740U and 1746

Codice Code	Tipo Size	Prezzo € Price €	Conf. Unit/Box
295 0014	-		1/25

**2971SET**

Set cappuccio e rosone per valvole ad incasso Art. 2960, 1690, 1690U, 1696, 1740, 1740U e 1746
Set cap and rounding for built-in valves for Art. 2960, 1690, 1690U, 1696, 1740, 1740U and 1746

Codice Code	Tipo Size	Prezzo € Price €	Conf. Unit/Box
295 0167	-		1/25

2960PR

Set prolunga per valvola ad incasso per 2960, 1690, 1690U, 1696, 1740, 1740U e 1746
 Spindle extension for built-in valve for 2960, 1690, 1690U, 1696, 1740, 1740U and 1746

Codice Code	Tipo Size	Prezzo € Price €	Conf. Unit/Box
295 0015	1/2"		1/100

2965

Valvola da incasso con vitone
 Built-in valve with head screw

Codice Code	Tipo Size	Prezzo € Price €	Conf. Unit/Box
295 0026	1/2"		10/30

2965PROL

Set prolunga per valvola ad incasso per 2965
 Spindle extension for built-in valve for 2965

Codice Code	Tipo Size	Prezzo € Price €	Conf. Unit/Box
295 0067	15		1/100

2970

Valvola pozzetto idrante
 Hydrant valve

Codice Code	Tipo Size	Prezzo € Price €	Conf. Unit/Box
295 0021	1/2"		12/36
295 0028	3/4"		10/30
295 0043	1"		5/15

3994

Valvola a saracinesca PN16
 Gate valve PN16

Codice Code	Tipo Size	Prezzo € Price €	Conf. Unit/Box
295 0061	1/2"		20/80
295 0041	3/4"		10/40
295 0048	1"		10/40
295 0047	1"1/4		5/20
295 0095	1"1/2		3/12
295 0045	2"		2/6
295 0069	2"1/2		1/5
295 0060	3"		1/5
295 0064	4"		1/2

3996L

Valvola a 3 vie
 3 ways ball valve

Codice Code	Tipo Size	Prezzo € Price €	Conf. Unit/Box
295 0068	3/8"		6/48
295 0025	1/2"		5/25
295 0031	3/4"		4/20
295 0030	1"		4/16
295 0051	1"1/4		1/5
295 0057	1"1/2		1/5
295 0052	2"		1/5

La valvola a 3 vie è disponibile anche con sfera a T 3996T / The 3 ways ball valve is also available with T ball 3996T

2990G

BOILER rubinetto a sfera per carico/scarico acqua
 BOILER drain ball valve with hose connection

Codice Code	Tipo Size	Prezzo € Price €	Conf. Unit/Box
295 0024	3/8"		25/100
295 0001	1/2"		25/100
295 0040	1/2"		10/50

Versione con laccio metallico / Metallic belt version

**3500**

Valvola di ritegno YACHT femmina/femmina ISO 228 con otturatore in nylon
Female/female ISO 228 check valve YACHT with nylon shutter

Codice Code	Tipo Size	Prezzo € Price €	Conf. Unit/Box
350 0003	1/2"		15/60
350 0004	3/4"		12/48
350 0001	1"		8/32
350 0006	1"1/4		6/24
350 0008	1"1/2		4/16
350 0007	2"		2/8
350 0022	2"1/2		1/6
350 0018	3"		1/4
350 0034	4"		1/2

**3600**

Valvola di ritegno YACHT femmina ISO 228 con filtro acciaio inox
Female ISO 228 check valve YACHT with stainless steel filter

Codice Code	Tipo Size	Prezzo € Price €	Conf. Unit/Box
350 0053	1/2"		8/80
350 0037	3/4"		8/48
350 0012	1"		7/63
350 0027	1"1/4		6/24
350 0039	1"1/2		4/20
350 0040	2"		2/18
350 0057	2"1/2		1/6
350 0059	3"		1/3
350 0065	4"		1/2

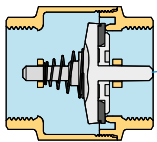

OTTURATORE
IN NYLON
NYLON
SHUTTER

**3505**

Valvola di ritegno YACHT femmina/femmina ISO 228 con otturatore metallico
Female/female ISO 228 check valve YACHT with metallic shutter

Codice Code	Tipo Size	Prezzo € Price €	Conf. Unit/Box
350 0030	1/2"		15/60
350 0021	3/4"		12/48
350 0013	1"		8/32
350 0025	1"1/4		6/24
350 0035	1"1/2		4/16
350 0031	2"		2/8
350 0050	2"1/2		1/6
350 0051	3"		1/4
350 0058	4"		1/2

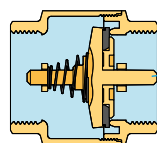

OTTURATORE
METALLICO
METALLIC
SHUTTER

**3510**

Filtro in acciaio inox per valvola di ritegno YACHT
Stainless steel filter for check valve YACHT

Codice Code	Tipo Size	Prezzo € Price €	Conf. Unit/Box
350 0054	1/2"		1/50
350 0044	3/4"		1/50
350 0029	1"		1/25
350 0038	1"1/4		1/20
350 0056	1"1/2		1/10
350 0052	2"		1/5
350 0064	2"1/2		1/4
350 0063	3"		1/3
350 0046	4"		1/2

**3660**

Valvola a clapet FULL femmina/
femmina ISO228 con otturatore
in ottone **con guarnizione**
Check valve FULL female/female
ISO228 with brass shutter **with**
sealing gaskets

Codice Code	Tipo Size	Prezzo € Price €	Conf. Unit/Box
350 0015	1/2"		25/75
350 0016	3/4"		15/45
350 0009	1"		10/30
350 0017	1"1/4		5/20
350 0020	1"1/2		5/15
350 0011	2"		2/12
350 0028	2"1/2		1/5
350 0026	3"		1/3
350 0042	4"		1/2

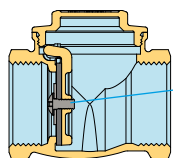

OTTURATORE
CON
GUARNIZIONE
SHUTTER WITH
SEALING GASKETS

**3665**

Valvola a clapet FULL femmina/
femmina ISO228 con otturatore
in ottone **senza guarnizione**
Check valve FULL female/female
ISO228 with brass shutter
without sealing gaskets

Codice Code	Tipo Size	Prezzo € Price €	Conf. Unit/Box
350 0135	1/2"		25/75
350 0136	3/4"		15/45
350 0137	1"		10/30
350 0138	1"1/4		5/20
350 0139	1"1/2		5/15
350 0140	2"		2/12

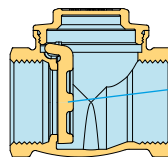

OTTURATORE
SENZA
GUARNIZIONE
SHUTTER
WITHOUT
SEALING GASKETS



**3651**

Valvola di fondo tubolare
femmina ISO 228
Female ISO 228 brass foot
tubular valve

Codice Code	Tipo Size	Ø	Prezzo € Price €	Conf. Unit/Box
350 0047	3/4"	30		5/25
350 0024	1"	37		4/20
350 0043	1"1/4	46		3/15
350 0049	1"1/2	54		4/12
350 0055	2"	65		2/6
350 0062	2"1/2	82		1/5
350 0061	3"	99		1/3
350 0060	4"	116		1

**3650**

Valvola di fondo GLOB femmina
ISO 228
Female ISO 228 check valve
GLOB

Codice Code	Tipo Size	Prezzo € Price €	Conf. Unit/Box
350 0175	1/2"		12/36
350 0033	3/4"		12/36
350 0010	1"		10/30
350 0014	1"1/4		6/18
350 0036	1"1/2		5/15
350 0032	2"		3/9
350 0048	2"1/2		1/6
350 0041	3"		1/3
350 0045	4"		1/5

**3670**

Filtro raccoglitore di impurità a Y
Y strainer

Foro solo per misura da 1/2"
For 1/2" hole only

CARATTERISTICHE TECNICHE:

- Grado di filtrazione: da 350 µ a 600 µ in funzione del diametro
- Materiale corpo: ottone C W 617N
- Pressione max di esercizio: 20 bar fino a 2"; 16 bar oltre 2"
- Temperatura max di esercizio: 100°C
- Filettature attacchi: femmina/femmina ISO 228

TECHNICAL CHARACTERISTICS:

- Performance: from 350 µ to 600 µ according to the diameter
- Body: CW 617N brass
- Max operating pressure: 20 bar up to 2"; 16 bar over 2"
- Max operating temperature: 100°C
- Threads: female/female ISO 228

Codice Code	Tipo Size	Prezzo € Price €	Conf. Unit/Box
367 0003	1/2"		35/105
367 0001	3/4"		18/54
367 0002	1"		10/30
367 0005	1"1/4		4/16
367 0009	1"1/2		3/12
367 0004	2"		2/8
367 0011	2"1/2		1/8
367 0014	3"		1/5
367 0015	4"		1/1

**3670CZISO7**

Filtro raccoglitore di impurità a Y
Y strainer

CARATTERISTICHE TECNICHE:

- Grado di filtrazione: da 350 µ a 500 µ in funzione del diametro
- Materiale corpo: ottone CW 602N
- Pressione max di esercizio: 20 bar
- Temperatura max di esercizio: 100°C
- Filettature attacchi: femmina/femmina ISO 7

TECHNICAL CHARACTERISTICS:

- Performance: from 350 µ to 500 µ according to the diameter
- Body: CW 602N brass
- Max operating pressure: 20 bar
- Max operating temperature: 100°C
- Threads: female/female ISO 7

Codice Code	Tipo Size	Prezzo € Price €	Conf. Unit/Box
367 0012	1/2"		25/75
367 0006	3/4"		15/45
367 0008	1"		8/24
367 0013	1"1/4		4/16
367 0010	1"1/2		3/12
367 0007	2"		2/8

**2091**

Leva alluminio rossa
Red aluminium handle

Codice Code	Tipo Size	VALVOLA CZ	URAGANO	SCIROCCO	MISTRAL	TORNADO	EOLO	TIFONE	Prezzo € Price €	Conf. Unit/Box
209 0009	1/2"	3/8"-1/2"	1/4"-3/8"-1/2"	1/4"-3/8"-1/2"-3/4"	1/2"-3/4"	1/2"-3/4"	3/8"-1/2"-3/4"-1"	1/2"		30/300
209 0007	3/4"	3/4"-1"	3/4"-1"	1"	1"-1"1/4	1"-1"1/4	-	3/4"-1"		15/150
209 0008	1"1/4	1"1/4-1"1/2-2"	1"1/4-1"1/2	1"1/4-1"1/2-2"	1"1/2-2"	1"1/2-2"	-	1"1/4-1"1/2		10/80
209 0012	2"	-	2"	-	-	-	-	2"		5/50
209 0019	2" 1/2	-	2"1/2-3-4"	2"1/2-3"-4"	-	-	-	2"1/2-3"-4"		1/30

**2092**

Leva farfalla rossa
Red T handle

Codice Code	Tipo Size	VALVOLA CZ	URAGANO	SCIROCCO	MISTRAL	TORNADO	EOLO	TIFONE	Prezzo € Price €	Conf. Unit/Box
209 0004	1/2"	3/8"-1/2"	1/2"	1/4"-3/8"-1/2"-3/4"	1/2"-3/4"	1/2"-3/4"	1/2"-3/4"-1"	1/2"		40/480
209 0011	3/4"	3/4"-1"	3/4"-1"	1"	1"-1"1/4	1"-1"1/4	-	3/4"-1"		20/240

**2092LOCK**

Leva farfalla rossa lucchettabile
Lockable red T handle

Codice Code	Tipo Size	URAGANO	TIFONE	Prezzo € Price €	Conf. Unit/Box
209 0027	1/2"	1/2"	1/2"		40/480
209 0060	3/4"	3/4"-1"	3/4"-1"		20/240

**2093R**

Leva piatta plastificata rossa
Red steel flat handle

Codice Code	Tipo Size	VALVOLA CZ	URAGANO	SCIROCCO	MISTRAL	TORNADO	EOLO	TIFONE	Prezzo € Price €	Conf. Unit/Box
209 0013	1/2"	3/8"-1/2"	1/4"-3/8"-1/2"	1/4"-3/8"-1/2"-3/4"	1/2"-3/4"	1/2"-3/4"	3/8"-1/2"-3/4"-1"	1/2"		30/300
209 0015	3/4"	3/4"-1"	3/4"-1"	1"	1"-1"1/4	1"-1"1/4	-	3/4"-1"		15/150
209 0017	1"1/4	1"1/4-1"1/2-2"	1"1/4-1"1/2-2"	1"1/4-1"1/2-2"	1"1/2-2"	1"1/2-2"	-	1"1/4-1"1/2-2"		10/100
209 0014	2"1/2	-	2"1/2-3"-4"	2"1/2-3"-4"	-	-	-	2"1/2-3"-4"		1/30

**2093LOCK**

Leva piatta plastificata rossa
lucchettabile
Red steel flat lockable handle

Disponibili anche in blu o verde
Also available in blue or green

Codice Code	Tipo Size	VALVOLA CZ	SCIROCCO	MISTRAL	TORNADO	EOLO	Prezzo € Price €	Conf. Unit/Box
209 0046	1/2"	3/8"-1/2"	3/8"-1/2"-3/4"	3/4"	1/2"-3/4"	3/8"-1/2"-3/4"-1"		30/300
209 0047	3/4"	3/4"-1"	1"	1"-1"1/4	1"-1"1/4	-		15/150
209 0048	1"1/4	1"1/4-1"1/2-2"	1"1/4-1"1/2-2"	1"1/2-2"	1"1/2-2"	-		10/100

**2094**

Prolunga leva per isolamento
Spindle extension for thermal
insulation

Codice Code	VALVOLA CZ	URAGANO	SCIROCCO	MISTRAL	TORNADO	TIFONE	Prezzo € Price €	Conf. Unit/Box
209 0001	3/8"-1/2"-Ø12-Ø15-Ø18-Ø22	1/4"-3/8"-1/2"	1/4"-3/8"-1/2"-3/4"	1/2"-3/4"	1/2"-3/4"	1/2"		40/120
209 0003	3/4"-1"-28	3/4"-1"	1"	1"-1"1/4	1"-1"1/4	3/4"-1"		30/90
209 0002	1"1/4-1"1/2-2"	1"1/4-1"1/2-2"	1"1/4-1"1/2-2"	1"1/2-2"	1"1/2-2"	1"1/4-1"1/2-2"		20/60
209 0006	-	2"1/2-3"-4"	2"1/2-3"-4"	-	-	2"1/2-3"-4"		5/15

**1872**

Levette per minivalvole
Handle for mini ball valve

Codice Code	Tipo Size	Prezzo € Price €	Conf. Unit/Box
179 0005	blu / blue		50/500
179 0007	rosso / red		50/500

**2096**

Set per 2980
Set for 2980

Codice Code	Tipo Size	Prezzo € Price €	Conf. Unit/Box
209 0010	1/4"		1/200

**2595**

Portagomma con ghiera e
guarnizione per serie EOLO
Hose-end and joint for ball
bibcock EOLO

Codice Code	F	Tipo Size	Ø	Prezzo € Price €	Conf. Unit/Box
250 0010	3/4"	1/2"	14		50/300
250 0014	1"	3/4"	20		25/150
250 0016	1"1/4	1"	25		10/80

**2962**

Rosone
Rosette

Codice Code	Tipo Size	Prezzo € Price €	Conf. Unit/Box
209 0005	1/2"		30/360



01

VALVOLE A SFERA E RUBINETTI IN OTTONE

BALL VALVES AND BRASS BIBCOCKS

Valvole e rubinetti per gas

Valves and bibcocks for gas

Valvole a sfera per gas a passaggio standard "TORNADO"
"TORNADO" standard bore ball valves for gas



50

Valvole a sfera per gas a passaggio totale "URAGANO"
"URAGANO" full bore ball valves for gas



51

Valvole a sfera per gas a passaggio totale "TIFONE"
"TIFONE" full bore ball valves for gas



53

Valvole a sfera per gas installazione post contatore
Ball valves to be installed after gas meter



54

Valvole a sfera per gas
General purpose ball valves for gas



56

Sistema sicurezza gas
Gas safety system



58

Ricambi
Spare parts



60

B



ERC



**2370G07**

Femmina/femmina ISO 7/EN
10226 con leva farfalla gialla
Female/female ISO 7 / EN 10226
with yellow T handle

Codice Code	Tipo Size	Prezzo € Price €	Conf. Unit/Box
239 0008	1/2"		25/100
239 0009	3/4"		15/60
239 0010	1"		8/32
239 0016	1"1/4		5/20

MOP 5

**2371G07**

Maschio/femmina ISO 7/EN
10226 con leva farfalla gialla
Male/female ISO 7 / EN 10226
with yellow T handle

Codice Code	Tipo Size	Prezzo € Price €	Conf. Unit/Box
239 0003	1/2"		25/100
239 0011	3/4"		15/60
239 0012	1"		8/32
239 0020	1"1/4		5/20

MOP 5

**2380G07**

Femmina/femmina ISO 7/EN
10226 con leva piatta plastificata
gialla
Female/female ISO 7/EN 10226
with yellow steel flat handle

Codice Code	Tipo Size	Prezzo € Price €	Conf. Unit/Box
239 0001	1/2"		20/80
239 0006	3/4"		10/40
239 0007	1"		8/32
239 0004	1"1/4		4/16
239 0002	1"1/2		3/12
239 0005	2"		2/8

MOP 5

**2381G07**

Maschio/femmina ISO 7/EN
10226 con leva piatta plastificata
gialla
Male/female ISO 7/EN 10226
with yellow steel flat handle

Codice Code	Tipo Size	Prezzo € Price €	Conf. Unit/Box
239 0013	1/2"		20/80
239 0014	3/4"		10/40
239 0015	1"		8/32
239 0018	1"1/4		4/16
239 0017	1"1/2		3/12
239 0019	2"		2/8

MOP 5

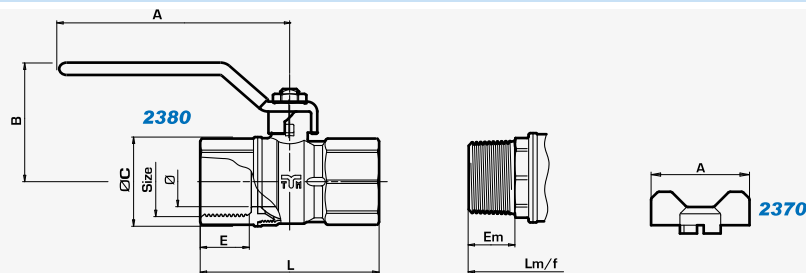
DIMENSIONI
DIMENSIONS

TABELLA DIMENSIONI / DIMENSION TABLE

Dimensione Size	Mod.	1/2"	3/4"	1"	1" 1/4	1" 1/2	2"
∅ (DN)	tutti/all	14,0	18,0	23,5	30,0	37,5	47,0
A	2370/2371	50,0	50,0	65,0	65,0	-	-
	2380/2381	85,0	85,0	113,0	113,0	141,0	141,0
B	tutti/all	48,0	52,5	59,5	64,5	76,0	89,0
∅ C	tutti/all	27,5	33,5	42,0	53,0	64,0	79,0
E	ISO 7	17,0	18,0	21,5	24,0	24,0	28,5
Em	ISO 7	16,5	18,0	21,0	23,5	23,5	28,0
L	ISO 7	58,0	66,5	78,0	93,0	101,0	121,0
Lm/f	ISO 7	63,5	72,0	83,0	99,1	108,0	129,0
PN		30	30	30	25	25	25

Tutte le dimensioni (ad eccezione del PN) sono espresse in mm / All dimensions (except for PN) are in mm

**2200G**

Femmina/femmina ISO 7/EN 10226 con leva piatta plastificata gialla
Female/female ISO 7/EN 10226 with yellow steel flat handle

Codice Code	Tipo Size	Prezzo € Price €	Conf. Unit/Box
221 0024	1/4"		25/100
221 0018	3/8"		25/100
221 0001	1/2"		20/80
221 0003	3/4"		10/40
221 0007	1"		8/32
221 0010	1"1/4		4/16
221 0011	1"1/2		3/12
221 0005	2"		2/8
221 0013	2"1/2		1/4
221 0014	3"		1/3
221 0019	4"		1/1

MOP 5

**2220G**

Femmina/femmina ISO 7/EN 10226 con leva farfalla gialla piombabile
Female/female ISO 7/EN 10226 with yellow T handle

Codice Code	Tipo Size	Prezzo € Price €	Conf. Unit/Box
221 0031	1/4"		25/100
221 0020	3/8"		25/100
221 0002	1/2"		20/80
221 0006	3/4"		15/60
221 0009	1"		8/32

MOP 5

**2240G**

Femmina/femmina ISO 7/EN 10226 con leva piombabile in ottone e cappuccio giallo in plastica
Female/female ISO 7/EN 10226 with sealable brass handle and yellow plastic cap

Codice Code	Tipo Size	Prezzo € Price €	Conf. Unit/Box
221 0033	1/2"		25/100
221 0029	3/4"		15/60
221 0021	1"		8/32
221 0030	1"1/4		4/16
221 0027	1"1/2		3/12
221 0028	2"		2/8

MOP 5

**2201G**

Maschio/femmina ISO 7/EN 10226 con leva piatta plastificata gialla
Male/female ISO 7/EN 10226 with yellow steel flat handle

Codice Code	Tipo Size	Prezzo € Price €	Conf. Unit/Box
221 0012	1/2"		20/80
221 0016	3/4"		10/40
221 0017	1"		8/32
221 0022	1"1/4		4/16
221 0023	1"1/2		3/12
221 0025	2"		2/8

MOP 5

**2221G**

Maschio/femmina ISO 7/EN 10226 con leva farfalla gialla piombabile
Male/female ISO 7/EN 10226 with yellow T handle

Codice Code	Tipo Size	Prezzo € Price €	Conf. Unit/Box
221 0026	3/8"		25/100
221 0004	1/2"		25/100
221 0008	3/4"		15/60
221 0015	1"		8/32

MOP 5

**2241G**

Maschio/femmina ISO 7/EN 10226 con leva piombabile in ottone e cappuccio giallo in plastica
Male/female ISO 7/EN 10226 with sealable brass handle and yellow plastic cap

Codice Code	Tipo Size	Prezzo € Price €	Conf. Unit/Box
221 0035	1/2"		25/100
221 0032	3/4"		15/60
221 0036	1"		8/32
221 0037	1"1/4		4/16
221 0038	1"1/2		3/12
221 0034	2"		2/8

MOP 5

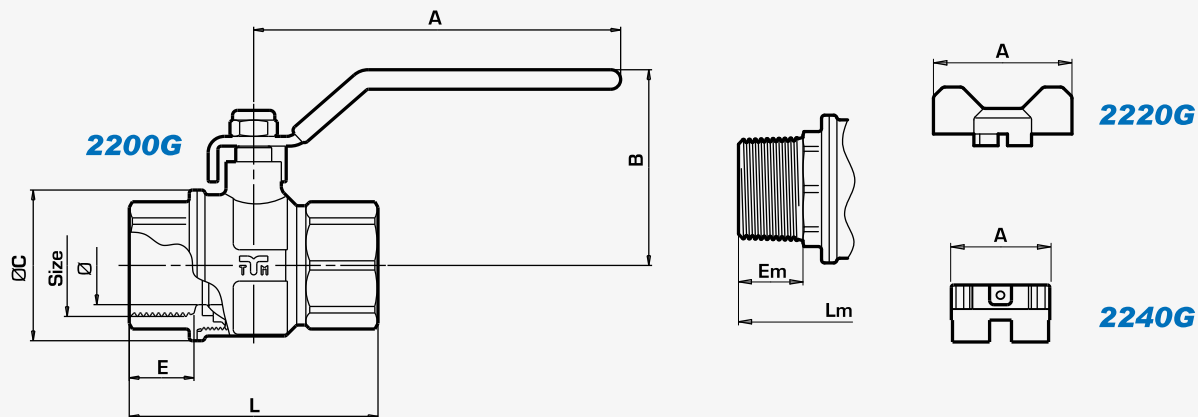
DIMENSIONI
 DIMENSIONS

TABELLA DIMENSIONI / DIMENSION TABLE

Dimensione Size	1/4"	3/8"	1/2"	3/4"	1"	1"1/4	1"1/2	2"	2"1/2	3"	4"
Ø (DN)	10	10	15	20	25	32	40	50	65	80	100
A 2200G	85	85	85	113	113	141	141	141	240	240	240
A 2220G	50	50	50	65	65	-	-	-	-	-	-
A 2240G	-	-	22	27	27	32	32	32	-	-	-
B	39	39	44.5	53.5	57.5	73.5	79.5	92	125.5	136	150.5
ØC	23	23	32.5	39	48	59	71	86	114	131	164
E	10	12	16.5	18	20.6	23.5	23.5	28	34	37	43
L	42	47	59.5	67.5	79	96	105	126	156	177	214
Em	-	11.5	16.5	18	21	23.5	23.5	28	-	-	-
Lm	-	57	67.5	75.5	87	106	114	136.5	-	-	-
PN	50	50	50	40	40	30	30	25	20	20	20

Tutte le dimensioni (ad eccezione del PN) sono espresse in mm / All dimensions (except for PN) are in mm

**2601G**

Maschio/femmina ISO 7/EN
10226 con leva piatta plastificata
gialla
Male/female ISO 7/EN 10226
with yellow steel flat handle

Codice Code	Tipo Size	Prezzo € Price €	Conf. Unit/Box
262 0017	1"1/4		4/16

Fino ad esaurimento scorta / until out of stock

**2621G**

Maschio/femmina ISO 7/EN
10226 con leva farfalla gialla
Male/female ISO 7/EN 10226
with yellow T handle

Codice Code	Tipo Size	Prezzo € Price €	Conf. Unit/Box
262 0012	1"		7/28

Fino ad esaurimento scorta / until out of stock

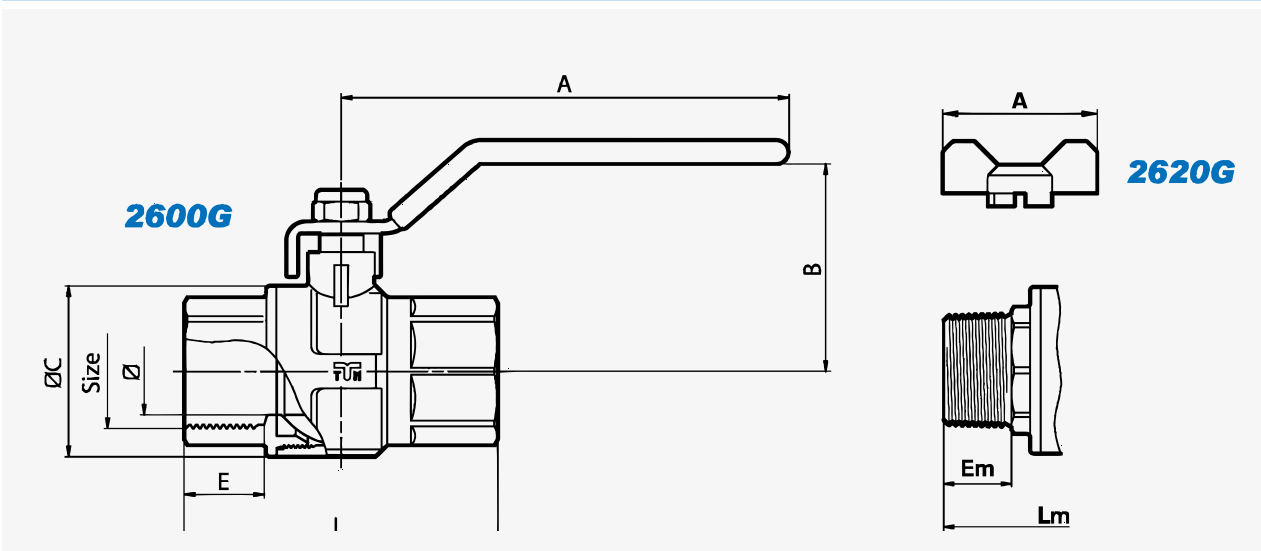
DIMENSIONI
 DIMENSIONS

TABELLA DIMENSIONI / DIMENSION TABLE

Dimensione Size	1"	1"1/4
Ø (DN)	25	32
A 2600G	112	142
A 2620G	65	-
B	59,5	74,5
Ø C	49	59
E	23	29,5
L	90	110,5
Em	20	22
Lm	92	110,5
PN	40	30

Tutte le dimensioni (ad eccezione del PN) sono espresse in mm / All dimensions (except for PN) are in mm

**PCONT01**

Valvola a sfera dritta a passaggio totale con punto di presa pressione, attacchi filettati maschio ISO228 e femmina ISO7/EN10226

Straight full bore ball valve, with pressure outlet point, male threaded ISO228 and female ISO7/EN10226

Codice Code	Tipo Size	Prezzo € Price €	Conf. Unit/Box
221 0050	3/4" F x 1" 1/4 M		10/40
221 0066	1" F x 1" 1/4 M		6/24

**PCONT01SER**

Valvola a sfera dritta a passaggio totale con punto di presa pressione, attacchi filettati maschio ISO228 e femmina ISO7/EN10226 con serratura di sicurezza e doppia chiave

Straight full bore ball valve with pressure outlet point male threaded ISO228 and female ISO7/EN10226. With safety lock and double key

Codice Code	Tipo Size	Prezzo € Price €	Conf. Unit/Box
221 0052	3/4" F x 1" 1/4 M		5/20
221 0068	1" F x 1" 1/4 M		5/20

**PCONT02**

Valvola a sfera dritta a passaggio totale con punto di presa pressione e attacchi filettati femmina ISO7/EN10226

Straight full bore ball valve with pressure outlet point female threaded ISO7/EN10226

Codice Code	Tipo Size	Prezzo € Price €	Conf. Unit/Box
221 0054	3/4" F x 3/4" F		10/40
221 0070	1" F x 1" F		5/20

**PCONT02SER**

Valvola a sfera dritta a passaggio totale con punto di presa pressione, attacchi filettati femmina ISO7/EN10226 con serratura di sicurezza e doppia chiave

Straight full bore ball valve with pressure outlet point female threaded ISO7/EN10226 with safety lock and double key

Codice Code	Tipo Size	Prezzo € Price €	Conf. Unit/Box
221 0056	3/4" F x 3/4" F		5/20
221 0072	1" F x 1" F		5/20

**PCONT03**

Valvola a sfera dritta a passaggio totale con punto di presa pressione, attacco filettato maschio ISO7/EN10226 su curva girevole a 360° e femmina ISO228 su dado folle

Straight full bore ball valve with pressure outlet point male threaded ISO7/EN10226 on 360° rotating curve, and female ISO228 idle nut

Codice Code	Tipo Size	Prezzo € Price €	Conf. Unit/Box
221 0058	1" M x 1" 1/4 F		5/20

Attacco diretto al contatore / Directly connected to the meter

**PCONT03SER**

Valvola a sfera dritta a passaggio totale con punto di presa pressione, attacco filettato maschio ISO7/EN10226 su curva girevole a 360° e femmina ISO228 su dado folle con serratura di sicurezza e doppia chiave

Straight full bore ball valve with pressure outlet point male threaded ISO7/EN10226 on 360° rotating curve, and female ISO228 idle nut with safety lock and double key

Codice Code	Tipo Size	Prezzo € Price €	Conf. Unit/Box
221 0060	1" M x 1" 1/4 F		5/20

Attacco diretto al contatore / Directly connected to the meter

**PCONT04**

Valvola a sfera dritta a passaggio totale con attacchi filettati femmina ISO7/EN10226 e ISO228 su dado folle

Straight full bore ball valve female threaded ISO7/EN10226 and ISO228 on idle nut

Codice Code	Tipo Size	Prezzo € Price €	Conf. Unit/Box
221 0062	1" F x 1" 1/4 F		5/20

Attacco diretto al contatore / Directly connected to the meter

**PCONT04SER**

Valvola a sfera dritta a passaggio totale con attacchi filettati femmina ISO7/EN10226 e ISO228 su dado folle con serratura di sicurezza e doppia chiave

Straight full bore ball valve female threaded ISO7/EN10226 and ISO228 on idle nut with safety lock and double key

Codice Code	Tipo Size	Prezzo € Price €	Conf. Unit/Box
221 0064	1" F x 1" 1/4 F		5/20

Attacco diretto al contatore / Directly connected to the meter

**PCONT05**

Valvola a sfera squadra a passaggio totale con punto di presa pressione, attacchi filettati maschio ISO228 e femmina ISO7/EN10226

Full bore angle ball valve with pressure outlet point, male threaded ISO228 and female threaded ISO7/EN10226

Codice Code	Tipo Size	Prezzo € Price €	Conf. Unit/Box
221 0074	3/4" F x 1" 1/4 M		10/40
221 0078	1" F x 1" 1/4 M		5/20

**PCONT05SER**

Valvola a sfera squadra a passaggio totale con punto di presa pressione, attacchi filettati maschio ISO 7 e femmina ISO7/EN10226 con serratura di sicurezza e doppia chiave

Full bore angle ball valve with pressure outlet point, male threaded ISO 7 and female ISO7/EN10226. With safety lock and double key

Codice Code	Tipo Size	Prezzo € Price €	Conf. Unit/Box
221 0076	3/4" F x 1" 1/4 M		5/20
221 0080	1" F x 1" 1/4 M		5/20

**PCONT07**

Valvola a sfera squadra a passaggio totale con punto di presa pressione, attacchi filettati femmina ISO7/EN10226

Full bore angle ball valve with pressure outlet point female threaded ISO7/EN10226

Codice Code	Tipo Size	Prezzo € Price €	Conf. Unit/Box
221 0083	3/4" F x 3/4" F		10/40
221 0084	1" F x 1" F		5/20

**PCONT07SER**

Valvola a sfera squadra a passaggio totale con punto di presa pressione, attacchi filettati femmina ISO 7/EN10226 con serratura di sicurezza e doppia chiave

Full bore angle ball valve with pressure outlet point female threaded female ISO7/EN10226. With safety lock and double key

Codice Code	Tipo Size	Prezzo € Price €	Conf. Unit/Box
221 0085	3/4" F x 3/4" F		5/20
221 0086	1" F x 1" F		5/20

**PCONT06**

Set codolo, girello e guarnizione con attacco filettato maschio ISO7/EN10226 e ISO228 sul dado

Set with O ring, nut and seal male threaded ISO 7/EN10226 and ISO228 on nut

Codice Code	Tipo Size	Prezzo € Price €	Conf. Unit/Box
221 0082	1" M x 1" 1/4 F		1/50

**PCONT08**

Valvola presa pressione di sicurezza

Safety pressure outlet valve

Codice Code	Tipo Size	Prezzo € Price €	Conf. Unit/Box
221 0088	1/4"		1/50



**2223G**

Valvola a squadra ISO 7/EN 10226 con leva farfalla gialla
Angle valve ISO 7/EN 10226 with yellow T handle

Codice Code	Tipo Size	Prezzo € Price €	Conf. Unit/Box
222 0001	1/2"		20/80
222 0016	3/4"		10/40

**2225G**

Valvole a squadra femmina/femmina ISO 7/EN 10226 con leva a farfalla gialla
Angle valve female/female ISO 7/EN 10226 with yellow T handle

Codice Code	Tipo Size	Prezzo € Price €	Conf. Unit/Box
222 0061	1/2"		15/60

**2226G**

Valvola a squadra femmina ISO 7/EN 10226 per Gas con girello
Female angle valve ISO 7/EN 10226 for Gas with loose nut/ Gas meter connection

Codice Code	Tipo Size	Prezzo € Price €	Conf. Unit/Box
222 0012	1/2"		20/80

**2224G**

Valvola a squadra maschio ISO 7/EN 10226 per Gas con girello
Male angle valve ISO 7/EN 10226 for Gas with loose nut/ Gas meter connection

Codice Code	Tipo Size	Prezzo € Price €	Conf. Unit/Box
222 0002	1/2" M x 1/2" F		20/80
222 0005	1/2" M x 3/4" F		20/80
222 0010	3/4" M x 3/4" F		10/40

**2250G**

Femmina ISO 7/EN 10226 con leva farfalla gialla
Female ISO 7/EN 10226 with yellow T handle and Gas hose connection

Codice Code	Tipo Size	Prezzo € Price €	Conf. Unit/Box
222 0018	1/2" x 13		20/80

**2251G**

Maschio ISO 7/EN 10226 con leva farfalla gialla
Male ISO 7/EN 10226 with yellow T handle Gas hose connection

Codice Code	Tipo Size	Prezzo € Price €	Conf. Unit/Box
222 0014	1/2" x 13		20/80

**2252G**

Femmina ISO 7/EN 10226 con leva farfalla gialla
Female ISO 7/EN 10226 with yellow T handle and Gas hose connection

Codice Code	Tipo Size	Prezzo € Price €	Conf. Unit/Box
222 0020	1/2" x 13		20/80

**2253G**

Maschio ISO 7/EN 10226 con leva farfalla gialla
Male ISO 7/EN 10226 with yellow T handle and Gas hose connection

Codice Code	Tipo Size	Prezzo € Price €	Conf. Unit/Box
222 0004	1/2" x 13		20/80

**2260G**

Valvola diritta femmina ISO 7/EN 10226 per Gas con girello
Female straight valve ISO 7/EN 10226 for Gas with loose nut/ Gas meter connection

Codice Code	Tipo Size	Prezzo € Price €	Conf. Unit/Box
222 0011	1/2"		20/80

**2261G**

Valvola diritta maschio ISO 7/EN 10226 per Gas con girello
Male straight valve ISO 7/EN 10226 for Gas with loose nut/ Gas meter connection

Codice Code	Tipo Size	Prezzo € Price €	Conf. Unit/Box
222 0007	1/2"		20/80

**2263G**

Valvola diritta femmina ISO 228 per Gas con girello
Female straight valve ISO 228 for Gas with loose nut/Gas meter connection

Codice Code	Tipo Size	Prezzo € Price €	Conf. Unit/Box
222 0015	1/2" x 1/2"		20/80
222 0008	3/4" x 3/4"		20/80
222 0017	1" x 1"		10/40
222 0040	1/2" x 3/4"		20/80
222 0041	3/4" x 1"		10/40

Versione nichelata / nickel-plated version

**2266G**

Valvola diritta maschio per Gas con girello
Male straight valve for Gas with loose nut/Gas meter connection

Codice Code	Tipo Size	Prezzo € Price €	Conf. Unit/Box
222 0058	1/2" M ISO7 - 1/2" F		20/80
222 0059	1/2" M ISO7 - 3/4" F		20/80
222 0060	3/4" M ISO7 - 3/4" F		20/80

**2697**

Valvola a sfera diritta con leva farfalla gialla e girello folle
Straight ball valve with yellow "T" handle and loose nut

Codice Code	Tipo Size	Prezzo € Price €	Conf. Unit/Box
260 0006	20 x 3/4"		20/80
260 0010	26 x 3/4"		20/80
260 0011	32 x 1"		10/40

**2692**

Valvola a sfera a squadra con leva farfalla gialla e girello folle
Angle ball valve with yellow "T" handle and loose nut

Codice Code	Tipo Size	Prezzo € Price €	Conf. Unit/Box
260 0004	20 x 3/4"		15/60
260 0014	25 x 3/4"		15/60
260 0005	26 x 3/4"		15/60
260 0012	32 x 1"		10/40

nuovo prodotto / new product

**2691**

Valvola a sfera con leva farfalla
Ball valve with T handle

Codice Code	Tipo Size	Prezzo € Price €	Conf. Unit/Box
260 0002	16 x 16		5/50
260 0003	20 x 20		5/50
260 0001	26 x 26		5/50

NEW

**3701G1**

Valvola SICURCASA ad incasso
compresa di cassetta in plastica
3/4" battuta piana
*sicurcasa flush mount valve
complete of 3/4" flat seal plastic
enclosure*

Codice Code	Tipo Size	Prezzo € Price €	Conf. Unit/Box
222 0066	3/4" M batt. piana / flat seal		1/5

3701G1 - GUIDA ALLE CONNESSIONI / CONNECTION GUIDE

Ø14; Ø16; Ø18; Ø22

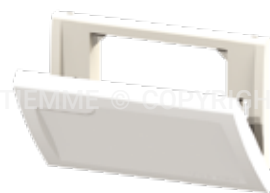
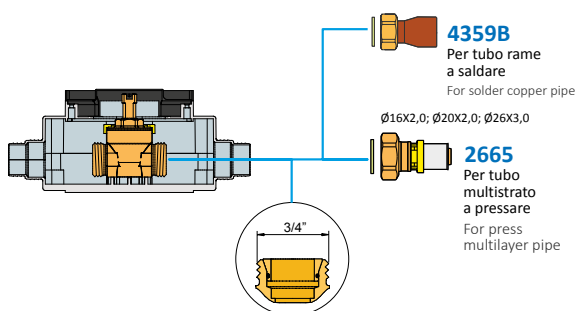
**3701PL**

Placca per cassetta ad incasso
valvola gas in plastica (3701G)
*Gas valve mounting enclosure
plate plastic (3701G)*

Codice Code	Tipo Size	Prezzo € Price €	Conf. Unit/Box
222 0044	bianca / white		10/40
222 0046	cromo satinata / satin chrome		10/40

Fino ad esaurimento scorta / until out of stock

**3701UG**

Valvola SICURCASA ad incasso
con geometria a U compresa di
cassetta in plastica, 3/4" battuta
piana
*Built-in valve U for gas
SICURCASA complete of 3/4" flat
seal plastic enclosure*

Codice Code	Tipo Size	Prezzo € Price €	Conf. Unit/Box
222 0050	3/4" M batt. piana / flat seal		1/6

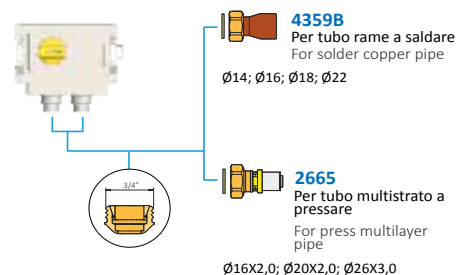
3701UG - GUIDA ALLE CONNESSIONI / CONNECTION GUIDE**3701G**

Valvola SICURCASA ad incasso
compresa di cassetta in plastica
3/4" battuta piana
*sicurcasa flush mount valve
complete of 3/4" flat seal plastic
enclosure*

Codice Code	Tipo Size	Prezzo € Price €	Conf. Unit/Box
222 0042	3/4" M batt. piana / flat seal		1/5

Fino ad esaurimento scorta / until out of stock

3701G - GUIDA ALLE CONNESSIONI / CONNECTION GUIDE

Ø14; Ø16; Ø18; Ø22

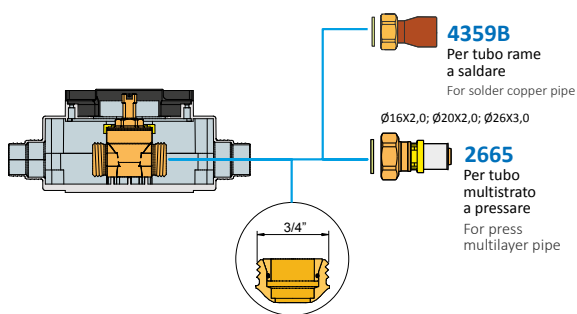
**3701UPL**

Placca per cassetta ad incasso
valvola gas (3701UG e 3701G1)
in plastica
*(3701UG and 3701G1) Gas valve
mounting enclosure plate plastic*

Codice Code	Tipo Size	Prezzo € Price €	Conf. Unit/Box
222 0052	bianca / white		1/25
222 0054	cromata / chrome		1/25

**1874**

Collettore in ottone CW617N giallo da 1" M con punto di presa pressione con uscite 3/4" M Interasse 45 mm
Manifold made of CW617N brass yellow with pressure outlet point with 3/4" M ways. Distance between centres 45 mm

Codice Code	Mandata Delivery	Uscite Output	N° vie N° ways	Prezzo € Price €	Conf. Unit/Box
183 0005	1"	3/4" M	2		1/5
183 0007	1"	3/4" M	3		1/5

1874 - GUIDA ALLE CONNESSIONI / CONNECTION GUIDE

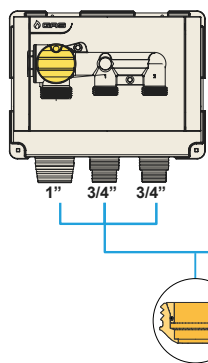
**4359B**

Per tubo rame a saldare
For solder copper pipe
Ø14; Ø16;
Ø18; Ø22

2665

Per tubo multistrato a pressare
For press multilayer pipe
Ø14; Ø16;
Ø18; Ø22

**1874PL**

Placca per cassetta incasso collettore 1874
Gas 1874 Manifold mounting enclosure plate

Codice Code	Tipo Size	Prezzo € Price €	Conf. Unit/Box
222 0062	2 vie bianca / 2 ways white		1/25
222 0064	3 vie bianca / 3 ways white		1/25

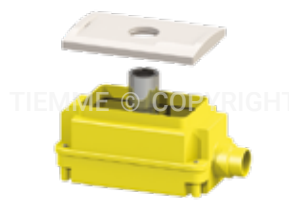
**1568BOX**

Raccordo curvo maschio-femmina nel box per gas
Male-female bent coupling for gas enclosure

Codice Code	Tipo Size	Prezzo € Price €	Conf. Unit/Box
150 0768	3/4" M batt. piana / flat seat x 1/2" F		1/5

**3701PROL**

Set prolunga SICURCASA per valvola 3701G
Spindle extension SICURCASA for 3701G

Codice Code	Tipo Size	Prezzo € Price €	Conf. Unit/Box
222 0048	per 3701G / for 3701G		1/25

3701PROL - ESEMPIO DI UTILIZZO / HOW TO USE

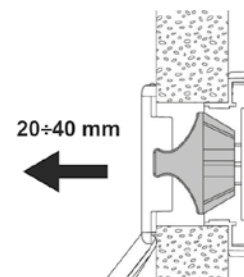

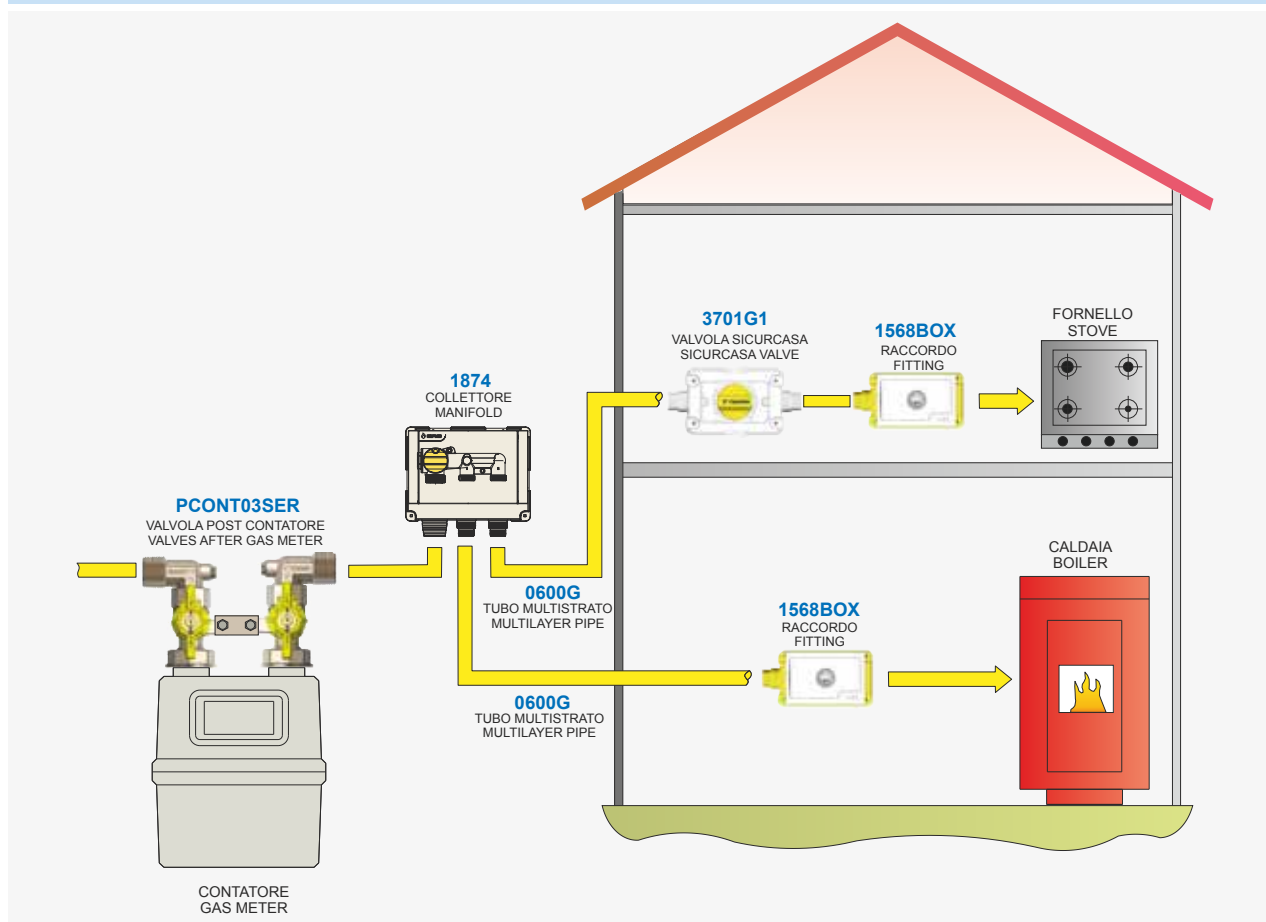
SCHEMA DI UTILIZZO
DIAGRAM OF USE**2093G**

Leva piatta plastificata gialla
Yellow plasticized steel flat
handle

Disponibile a richiesta
Available on request

Codice Code	Tipo Size	TORNADO	URAGANO	TIFONE	Prezzo € Price €	Conf. Unit/Box
209 0070	1/2"	1/2"-3/4"	1/4"-3/8"-1/2"	1/2"		30/300
209 0062	3/4"	1"-1"1/4"	3/4"-1"	3/4"-1"		15/150
209 0028	1"1/4"	1"1/2-2"	1"1/4-1"1/2-2"	1"1/4-1"1/2-2"		10/100
209 0044	2"1/2"	-	2"1/2-3"-4"	-		1/30